



**PLEASE CHECK FOR CHANGE INFORMATION  
AT THE REAR OF THIS MANUAL.**



**TM 5003  
POWER MODULE**

INSTRUCTION MANUAL

Tektronix, Inc.  
P.O. Box 500  
Beaverton, Oregon 97077

Serial Number \_\_\_\_\_

070-2955-00

First Printing JAN 1981  
Revised SEP 1981

Copyright © 1981, Tektronix, Inc. All rights reserved.  
Contents of this publication may not be reproduced in  
any form without the written permission of Tektronix, Inc.

Products of Tektronix, Inc. and its subsidiaries are  
covered by U.S. and foreign patents and/or pending  
patents.

TEKTRONIX, TEK, SCOPE-MOBILE, and  are reg-  
istered trademarks of Tektronix, Inc. TELEQUIPMENT is  
a registered trademark of Tektronix U.K. Limited.

Printed in U.S.A. Specification and price change  
privileges are reserved.

# TABLE OF CONTENTS

|   |     |
|---|-----|
| <b>LIST OF ILLUSTRATIONS</b> .....      | ii  |
| <b>LIST OF TABLES</b> .....             | iii |
| <b>OPERATORS'S SAFETY SUMMARY</b> ..... | iv  |
| <b>SERVICE SAFETY SUMMARY</b> .....     | v   |

## Section 1 SPECIFICATION

|                                     |     |
|-------------------------------------|-----|
| Instrument Description .....        | 1-1 |
| Performance Conditions .....        | 1-1 |
| Electrical Characteristics .....    | 1-1 |
| Environmental Characteristics ..... | 1-4 |
| Physical Characteristics .....      | 1-5 |

## Section 2 OPERATING INSTRUCTIONS

|  |     |
|--|-----|
| Introduction .....                     | 2-1 |
| Power Source Requirements .....        | 2-1 |
| Fuse Replacement .....                 | 2-1 |
| Table Top Use .....                    | 2-1 |
| Plug-in Installation and Removal ..... | 2-1 |
| Family Compatibility .....             | 2-2 |
| Customizing the Interface .....        | 2-2 |
| Rear Panel .....                       | 2-2 |
| Option 02 .....                        | 2-2 |
| Repackaging Information .....          | 2-2 |
| Stacking and Rackmounting .....        | 2-4 |



*The following servicing instructions are for use by qualified personnel only. To avoid personal injury, do not perform any servicing other than that contained in operating instructions unless you are qualified to do so.*

## Section 3 THEORY OF OPERATION

|   |     |
|---|-----|
| Introduction .....                          | 3-1 |
| Line Selector and 60 Hz Transformer .....   | 3-1 |
| Rectifiers and Filters .....                | 3-1 |
| 20 kHz Output Stage .....                   | 3-1 |
| Control Logic and Drivers .....             | 3-1 |
| Output Regulator .....                      | 3-3 |
| Overvoltage and Overcurrent Detectors ..... | 3-4 |
| Control Circuit Regulator .....             | 3-4 |
| Main Interface .....                        | 3-5 |

## Section 4 CALIBRATION

|                                       |     |
|---------------------------------------|-----|
| Performance Check Procedure .....     | 4-1 |
| Introduction .....                    | 4-1 |
| Test Equipment Required .....         | 4-1 |
| Test Loads for the Performance        |     |
| Check Procedure .....                 | 4-1 |
| Performance Check Summary Sheet ..... | 4-4 |
| Internal Adjustment Procedure .....   | 4-5 |
| Introduction .....                    | 4-5 |
| Services Available .....              | 4-5 |
| Test Equipment Required .....         | 4-5 |
| Adjustment Access .....               | 4-5 |
| Power Limit Adjustment .....          | 4-5 |

## Section 5 MAINTENANCE

|                                   |     |
|-----------------------------------|-----|
| Preparation for Use .....         | 5-1 |
| Static Sensitive Components ..... | 5-1 |
| Cleaning .....                    | 5-2 |
| Obtaining Replacement Parts ..... | 5-2 |
| Soldering Techniques .....        | 5-3 |
| Semiconductors .....              | 5-3 |
| Multipin Connectors .....         | 5-3 |
| Instrument Disassembly .....      | 5-3 |
| Circuit Troubleshooting .....     | 5-6 |
| Rear Interface Information .....  | 5-7 |
| PWR Indicator .....               | 5-7 |
| Pin Assignments .....             | 5-7 |

## Section 6 OPTIONS

|                                |     |
|--------------------------------|-----|
| Introduction Option 02 .....   | 6-1 |
| System Design Directions ..... | 6-1 |
| Wire Use .....                 | 6-1 |

## Section 7 REPLACEABLE ELECTRICAL PARTS

### Section 8 DIAGRAMS AND CIRCUIT BOARD ILLUSTRATIONS

|                            |  |
|----------------------------|--|
| Component Reference Charts |  |
| Schematic Diagrams         |  |

### Section 9 REPLACEABLE MECHANICAL PARTS

|                      |  |
|----------------------|--|
| Fig. 1 Exploded View |  |
| Accessories          |  |

## CHANGE INFORMATION

# LIST OF ILLUSTRATIONS

| <b>Fig.<br/>No.</b> |   | <b>Page</b> |
|---------------------|---|-------------|
| 2-1                 | TM 5003 rear panel . . . . .  | 2-2         |
| 2-2                 | TM 5003 bottom view . . . . .   | 2-3         |
| 2-3                 | TM 5003 front view . . . . .  | 2-4         |
| 2-4                 | Plug-in installation and removal. . . . .   | 2-5         |
| 2-5                 | Keying assignments for family functions.<br>One of the many possible sequence<br>combinations . . . . .             | 2-5         |
| 3-1                 | Various waveforms and time relationships<br>for power on, off, fault and low line. . . . .                          | 3-2         |
| 3-2                 | Input line connections for 110 V and<br>220 V operation. . . . .  | 3-3         |
| 4-1                 | Possible loads for use in performance<br>check procedure. See text . . . . .  | 4-1         |
| 4-2                 | Test setup for performance check steps<br>1, 2 and 3 and location of connections<br>for adjustment step 1 . . . . . | 4-3         |
| 4-3                 | Location of voltage buses and adjustments   | 4-5         |
| 5-1                 | Line cord options for the TM 5003 . . . . .   | 5-1         |
| 5-2                 | Line voltage jumper positions . . . . .   | 5-2         |
| 5-3                 | Orientation and disassembly of multipin<br>connector. . . . .   | 5-3         |
| 5-4                 | Rear view of TM 5003. . . . .   | 5-4         |
| 5-5                 | Guide rail and air baffle removal. . . . .  | 5-4         |
| 5-6                 | Removal of interface circuit board support.   | 5-4         |
| 5-7                 | Removal of dc power supply primary board  | 5-4         |
| 5-8                 | Partial dc power supply primary board<br>removal . . . . .  | 5-5         |
| 5-9                 | Secondary board and partial primary<br>transformer removal. . . . .   | 5-5         |
| 5-10                | Location of PNP series pass transistors<br>and partial transformer removal . . . . .                                | 5-5         |
| 5-11                | NPN Series Pass Transistors . . . . .   | 5-5         |
| 5-12                | PWR signal timing diagram . . . . .   | 5-7         |
| 5-13                | Rear interface connector assignments . . . . .  | 5-8         |
| 5-14                | Rear panel GPIB connector J1110 viewed<br>from rear of power module (IEEE Standard<br>No. 488). . . . .             | 5-9         |
| 8-1                 | Dc power supply, primary, secondary and<br>line filter boards   |             |
| 8-2                 | Dc power supply regulator waveforms   |             |
| 8-3                 | Main interface board (A10)  |             |
| 8-4                 | GPIB interconnect board (back side)   |             |

# LIST OF TABLES

| <b>Table No.</b> |   | <b>Page</b> |
|------------------|---|-------------|
| 1-1              | Electrical Characteristics . . . . .                            | 1-1         |
| 1-2              | Environmental Characteristics . . . . .                         | 1-4         |
| 1-3              | Physical Characteristics . . . . .                              | 1-5         |
| 4-1              | Suggested Test Equipment . . . . .                              | 4-2         |
| 5-1              | Relative Susceptibility to Static Discharge<br>Damage . . . . . | 5-2         |
| 8-1              | Partial A11, A13 and A14 Component<br>Reference Chart           |             |
| 8-2              | Partial A11 Component Reference Chart                           |             |
| 8-3              | A10 Component Reference Chart                                   |             |

# OPERATORS SAFETY SUMMARY

The general safety information in this part of the summary is for both operating and servicing personnel. Specific warnings and cautions will be found throughout the manual where they apply, but may not appear in this summary.

## TERMS

### In This Manual

CAUTION statements identify conditions or practices that could result in damage to the equipment or other property.

WARNING statements identify conditions or practices that could result in personal injury or loss of life.

### As Marked on Equipment

CAUTION indicates a personal injury hazard not immediately accessible as one reads the marking, or a hazard to property including the equipment itself.

DANGER indicates a personal injury hazard immediately accessible as one reads the marking.

## SYMBOLS

### In This Manual



This symbol indicates where applicable cautionary or other information is to be found.

### As Marked on Equipment



DANGER — High voltage.



Protective ground (earth) terminal.



ATTENTION — refer to manual.

### Power Source

This product is intended to operate from a power source that will not apply more than 250 volts rms between the supply conductors or between either supply conductor and ground. A protective ground connection by way of the grounding conductor in the power cord is essential for safe operation.

### Grounding the Product

This product is grounded through the grounding conductor of the power module power cord. To avoid electrical shock, plug the power cord into a properly wired receptacle before connecting to the product input or output terminals. A protective ground connection by way of the grounding conductor in the power module power cord is essential for safe operation.

### Danger Arising From Loss of Ground

Upon loss of the protective-ground connection, all accessible conductive parts (including knobs and controls that may appear to be insulating) can render an electric shock.

### Use the Proper Fuse

To avoid fire hazard, use only the fuse of correct type, voltage rating and current rating as specified in the parts list for your product.

Refer fuse replacement to qualified service personnel.

### Do Not Operate in Explosive Atmospheres

To avoid explosion, do not operate this product in an explosive atmosphere unless it has been specifically certified for such operation.

### Do Not Operate Without Covers

To avoid personal injury, do not remove the product covers or panels. Do not operate the product without the covers and panels properly installed.

# SERVICE SAFETY SUMMARY

## FOR QUALIFIED SERVICE PERSONNEL ONLY

*Refer also to the preceding Operators Safety Summary.*

### **Do Not Service Alone**

Do not perform internal service or adjustment of this product unless another person capable of rendering first aid and resuscitation is present.

### **Use Care When Servicing With Power On**

Dangerous voltages may exist at several points in this product. To avoid personal injury, do not touch exposed connections and components while power is on.

Disconnect power before removing protective panels, soldering, or replacing components.

### **Power Source**

This product is intended to operate from a power source that will not apply more than 250 volts rms between the supply conductors or between either supply conductor and ground. A protective ground connection by way of the grounding conductor in the power cord is essential for safe operation.

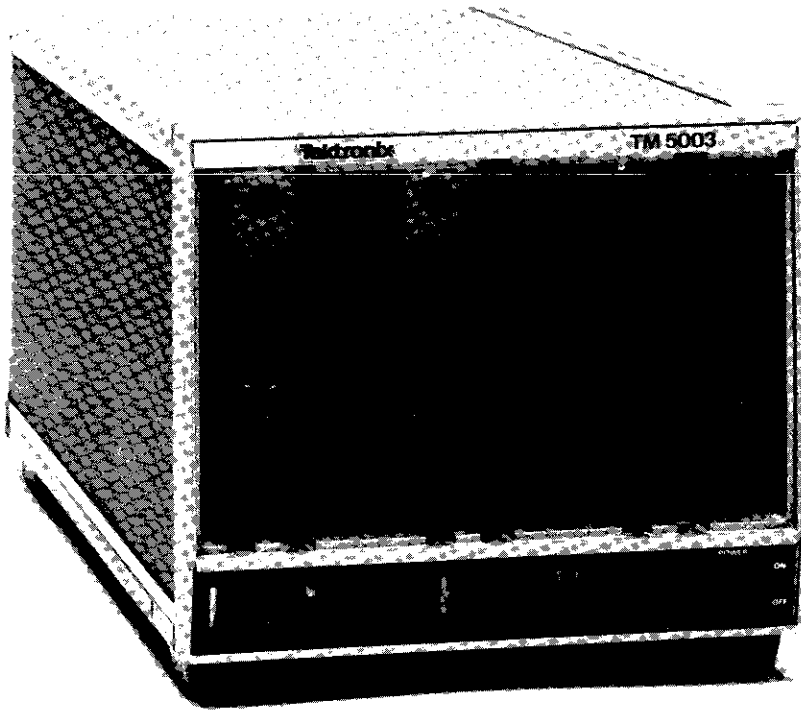

2955-00

TM 5003 Power Module



# SPECIFICATION

## Instrument Description

The TM 5003 is a three compartment power module compatible with TM 500 - 5000 series plug-ins. The power module features a pulse width modulated switching dc power supply. All dc voltages are regulated. The unit has forced air cooling.

Three individual connectors, one for each compartment, provide connections to each GPIB compatible plug-in. These connectors feed to a GPIB interface board, then to a standard GPIB connector on the rear panel. All GPIB connections are separate from the board rear interface connector.

## Performance Conditions

The electrical characteristics in this specification are valid only if the TM 5003 has been adjusted at an ambient temperature between +20°C and +30°C. The instrument must

be in a noncondensing environment whose limits are described under the environmental part. Allow 30 minutes warm-up time for operation to specified accuracy; 60 minutes after exposure to or storage in a high humidity (condensing) environment. Any conditions that are unique to a particular characteristic are expressly stated as part of that characteristic.

The electrical and environmental performance limits; together with their related validation procedures, comprise a complete statement of the electrical and environmental performance of a calibrated instrument.

Items listed in the Performance Requirements column of the Electrical Characteristics are verified by completing the Performance Check in the Calibration section of this manual. Items listed in the Supplemental Information column are not verified in this manual.

**Table 1-1  
ELECTRICAL CHARACTERISTICS**

| Characteristics              | Performance Requirements | Supplemental Information |
|------------------------------|--------------------------|--------------------------|
| <b>Supplies</b>              |                          |                          |
| +26 V dc                     |                          |                          |
| Tolerance <sup>a</sup>       | +23.7 V to 28.3 V        |                          |
| PARD <sup>b</sup>            |                          | ≤2.5 V peak to peak      |
| Maximum load                 |                          | 1 A per compartment      |
| Maximum load $\frac{di}{dt}$ |                          | 10 mA/μs                 |
| -26 V dc                     |                          |                          |
| Tolerance <sup>a</sup>       | -23.7 V to -28.3 V       |                          |
| PARD <sup>b</sup>            |                          | ≤2.5 V peak to peak      |
| Maximum load                 |                          | 1 A per compartment      |
| Maximum load $\frac{di}{dt}$ |                          | 10 mA/μs                 |

Table 1-1 (cont)

| Characteristics  | Performance Requirements | Supplemental Information  |
|--|--------------------------|---|
| +8 V dc  |                          |   |
| Tolerance <sup>a</sup>                                 | +7.6 V to +8.5 V         |   |
| PARD <sup>b</sup>                                      |                          | ≤600 mV peak to peak  |
| Maximum load   |                          | 3 A per compartment   |
| Maximum load $\frac{di}{dt}$                           |                          | 20 mA/μs  |
| 25 V ac (2 each compartment)                           |                          |   |
| Range  |                          | 25.0 V rms +10%, -15% floating  |
| Maximum load   |                          | 1 A rms per winding   |
| Maximum floating voltage                               |                          | 350 V peak from chassis ground  |
| 17.5 V   |                          |   |
| Range  |                          | 20.5 V +10%, -20% with grounded center tap  |
| Maximum load   |                          | 350 mA per compartment  |
| Maximum plug-in power <sup>c</sup> draw from mainframe |                          | 30 watts dc or 50 VA ac   |
| Combined power draw <sup>c</sup> Sharing Limitation    |                          | $VA_{ac} + 2.67 (\text{watts}_{dc}) \leq 100$   |
| <b>Series Pass Transistors</b>                         |                          |   |
| Type   |                          | One NPN and PNP per compartment   |
| Maximum dissipation                                    |                          | 10 W each, 20 W total   |
| Maximum floating voltage                               |                          | 350 V peak  |
| <b>Source Power Requirements</b>                       |                          |   |
| Voltage Ranges   |                          | Selectable (nominal):<br>100 V, 110 V, 120 V, 200 V,<br>220 V, and 240 V. (250 V<br>maximum on 240 V range) |
| Tolerance  |                          | +7% - 10%   |
| Line Frequency   |                          | 48 Hz to 60 Hz  |
| Maximum Power Consumption                              |                          | 300 VA  |

Table 1-1 (cont)

| Characteristics   | Performance Requirements | Supplemental Information |
|---|--------------------------|--------------------------|
| Fuse Data<br>100 V, 110 V, 120 V ranges                   |                          | 4 A, 3 AG, medium blow   |
| 200 V, 220 V, 240 V ranges                                |                          | 2 A, 3 AG, fast blow     |
| <b>Miscellaneous</b>                                      |                          |                          |
| Maximum recommended plug-in power dissipation<br>One-wide |                          | 15 W                     |
| Two-wide  |                          | 35 W                     |
| Recommended adjustment interval                           |                          | 1000 hours or 6 months   |

<sup>a</sup>Worst case: Low line with full load and high line with no load. These limits include PARD.

<sup>b</sup>Periodic and Random Deviation. See National Electrical Manufacturers Association (NEMA) Standards Publication No. PY1-1972.

<sup>c</sup>At nominal line voltage.

**Table 1-2  
ENVIRONMENTAL CHARACTERISTICS**

| Characteristics             | Description   |
|-----------------------------|---|
| Temperature                 | Meets MIL-T-28800B, class 5.  |
| Operating <sup>a</sup>      | 0°C to +50°C  |
| Non-operating               | -55°C to +75°C  |
| Humidity <sup>a</sup>       | Exceeds MIL-T-28800B, class 5.  |
|                             | 95% RH, 0°C to 30°C   |
|                             | 75% RH, to 40°C   |
|                             | 45% RH, to 50°C   |
| Altitude                    | Exceeds MIL-T-28800B, class 5.  |
| Operating <sup>a</sup>      | 4.6 Km (15,000 ft)  |
| Non-operating               | 15 Km (50,000 ft)   |
| Vibration <sup>c</sup>      | Meets MIL-T-28800B, class 5.  |
|                             | 0.38 mm (0.015") peak to peak, 5 Hz to 55 Hz, 75 minutes.   |
| Shock <sup>c</sup>          | Meets MIL-T-28800B, class 5.  |
|                             | 30 g's (1/2 sine) 11 ms duration, 3 shocks in each direction along 3 major axes, 18 total shocks. |
| Bench Handling <sup>c</sup> | Meets MIL-T-28800B, class 5.  |
|                             | 12 drops from 45° 4" or equilibrium, whichever occurs first.                                      |
| Transportation <sup>d</sup> | Qualified under National Safe Transit Association Preshipment Test Procedures 1A-B-1 and 1A-B-2.  |
| EMC                         | Within limits of MIL-461A tests RE02, CE01, CE03, RS01, CS01, CS02 and VDE 0871.                  |
| Electrical Discharge        | 20 kV maximum charge applied to instrument case.  |

<sup>a</sup>Electrical load in accordance with Section 2.2.1.

<sup>b</sup>System environmental specifications subject to individual plug-in specifications.

<sup>c</sup>Tested with mechanical load of 9.5 lbs. ± 1/2 lb. evenly distributed. (A three-wide plug-in with three rear support pins and two rear interface ECB's.) Requires retainer clips.

<sup>d</sup>Without mechanical load (plug-ins).

**Table 1-3  
PHYSICAL CHARACTERISTICS**

| <b>Characteristics</b>                    | <b>Description</b>                 |
|---|------------------------------------|
| Maximum recommended plug-in weight        |                                    |
| One wide                                  | 3 lbs (1.4 kg)                     |
| Two wide                                  | 6 lbs (2.7 kg)                     |
| Net weight (without plug-ins)             | 19 lbs (8.6 kg)                    |
| Maximum overall dimensions                |                                    |
| Height                                    | 193.8 mm (7.63 inches)             |
| Width                                     | 229.84 mm (9.049 inches)           |
| Length                                    | 476 mm (18.74 inches)              |
| Enclosure type and style per MIL-T-28800B |                                    |
| Type                                      | iii                                |
| Style                                     | E (with 040 rackmount kit style F) |
| Finish                                    |                                    |
| Frame                                     | Powder coated aluminum             |
| Covers                                    | Vinyl clad aluminum                |



# OPERATING INSTRUCTIONS

## Introduction

The TM 5003 Power Module is calibrated and ready for use when received. A list of standard accessories (and part numbers) is located in the back of this manual.

### CAUTION

*To ensure proper cooling, do not operate the power module with any cover removed.*

## Power Source Requirements

### WARNING

**AC Power Source and Connection.** *This instrument operates from a single-phase power source. It has a three-wire power cord and two-pole, three-terminal grounding type plug. The voltage to ground (earth) from either pole of the power source must not exceed the maximum rated operating voltage, 250 volts.*

*Before making connection to the power source, determine that the instrument is adjusted to match the voltage of the power source, and has a suitable two-pole, three-terminal grounding-type plug. Refer any changes to qualified service personnel.*

**Grounding.** *This instrument is safety class I equipment (IEC designation). All accessible conductive parts are directly connected through the grounding conductor of the power cord to the grounding contact of the power plug.*

*The power input plug must only be inserted in a mating receptacle with a grounding contact. Do not defeat the grounding connection. Any interruption of the grounding connection can create an electric shock hazard.*

*For electric shock protection, the grounding connection must be made before making connection to the instrument's input or output terminals.*

See Fig. 2-1. Refer to the line voltage and fuse data label on the rear panel.

## Fuse Replacement

Turn the slotted section of the line fuse holder counter-clockwise and remove the fuse. Replace the fuse with the proper type as shown on the rear panel label.

## Table Top Use

The power module may be operated with the front raised. To raise the front of the instrument extend the front feet as shown in Fig. 2-2.

## Plug-In Installation and Removal

### CAUTION

*Turn the power module off before inserting or removing the plug-in; otherwise, damage may occur to the plug-in circuitry.*

### NOTE

*The DC 505, DC 505A and LA 501W plug-ins are not compatible with this power module.*

Check to see that the plastic barriers on the interconnecting jack of the selected power module compartment match the cutouts in the plug-in circuit board edge connector. Align the plug-in chassis with the upper and lower guides (see Fig. 2-3 and 2-4) of the selected compartment. Push the plug-in chassis in and press firmly to seat the circuit board edge connector in the interconnecting jack. Turn the power module on.

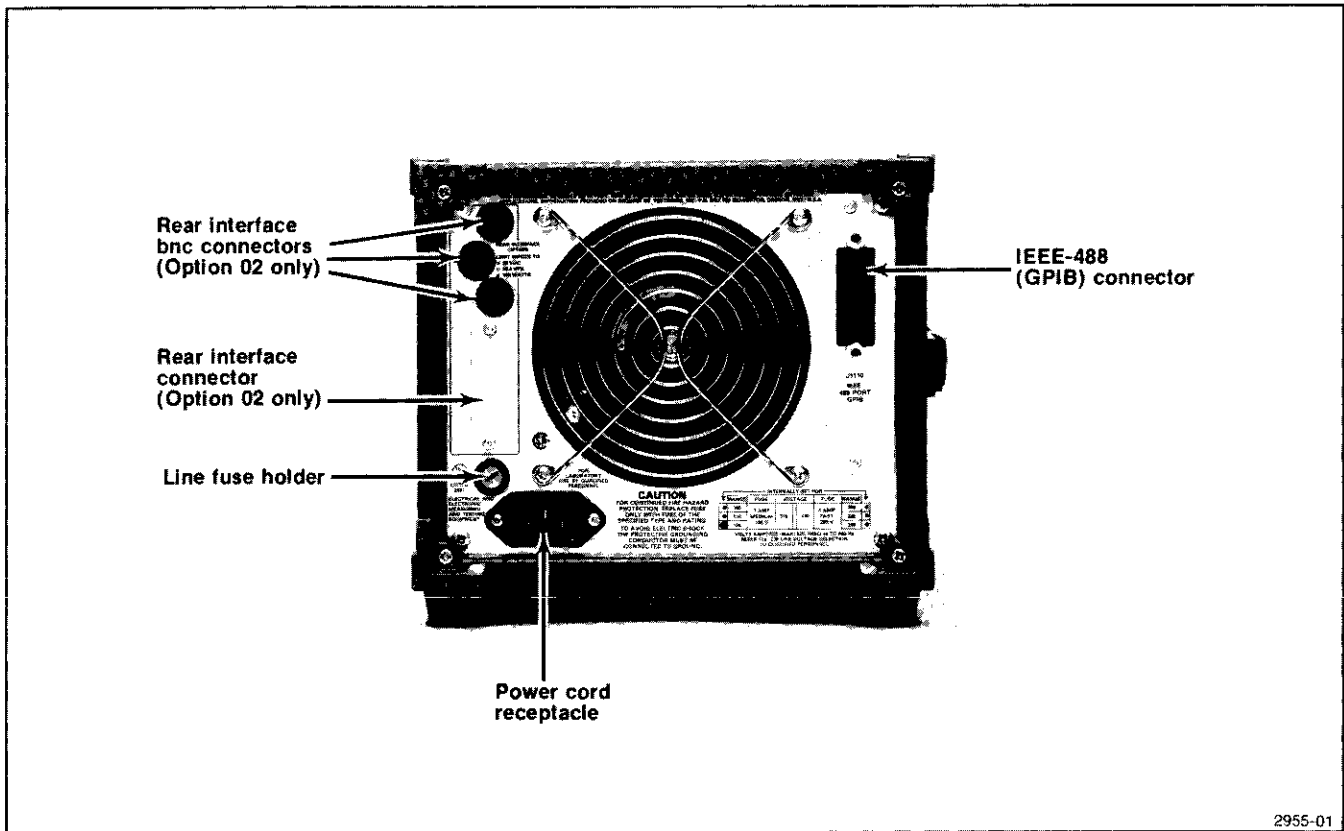

Fig. 2-1. TM 5003 rear panel.

**Family Compatibility**

Mechanically, TM 500 - 5000 plug-in modules are very similar to other Tektronix product families. However, they are not electrically compatible. Therefore, the TM 5003 interface has barriers on the mating connectors between pins 6 and 7 to ensure that incompatible plug-ins cannot be inserted. See Fig. 2-5. A compatible module will have a matching slot between pins 6 and 7 of its main circuit board edge connector. This slot and barrier combination is the primary keying assignment.

TM 500-5000 compatible plug-in modules are also identified by the white color of the release latch.

**Customizing the Interface**

The modularity of this instrumentation system provides for many different functions to be performed by the plug-in modules. Specific functions are grouped into families or classes, of which there may be several plug-in module members. For instance, some classes are Power Supplies, Signal Sources, Measurement, and so forth. Each module member of a functional family will have a second slot, peculiar to its family assignment, located in its edge connector. The TM 5003 user can select one or more compartments, to accept only members of that family, by installing a second

barrier in the interface connector to match the module's slot location. An entire TM 5003 can be set up in this manner for specific work functions. For extra barriers, order Tektronix Part No. 214-1593-02.

**Rear Panel**

The rear subpanel has a connector mounting plate for bnc and multipin connector mountings. Customer or factory-installed connectors and wiring (Option 02) can provide external access to the interface. This feature makes the TM 500-5000 Series Modular Instrumentation System very flexible in bench-top or rack mounted systems.

**Option 02**

Qualified service personnel see Section 6 in the Service Section of this manual for information on Option 02.

**Repackaging Information**

If the Tektronix instrument is shipped to a Tektronix Service Center for service or repair, attach a tag showing owner (with address) and the name of an individual at your firm to contact. Include the complete instrument serial number and a description of the service required.



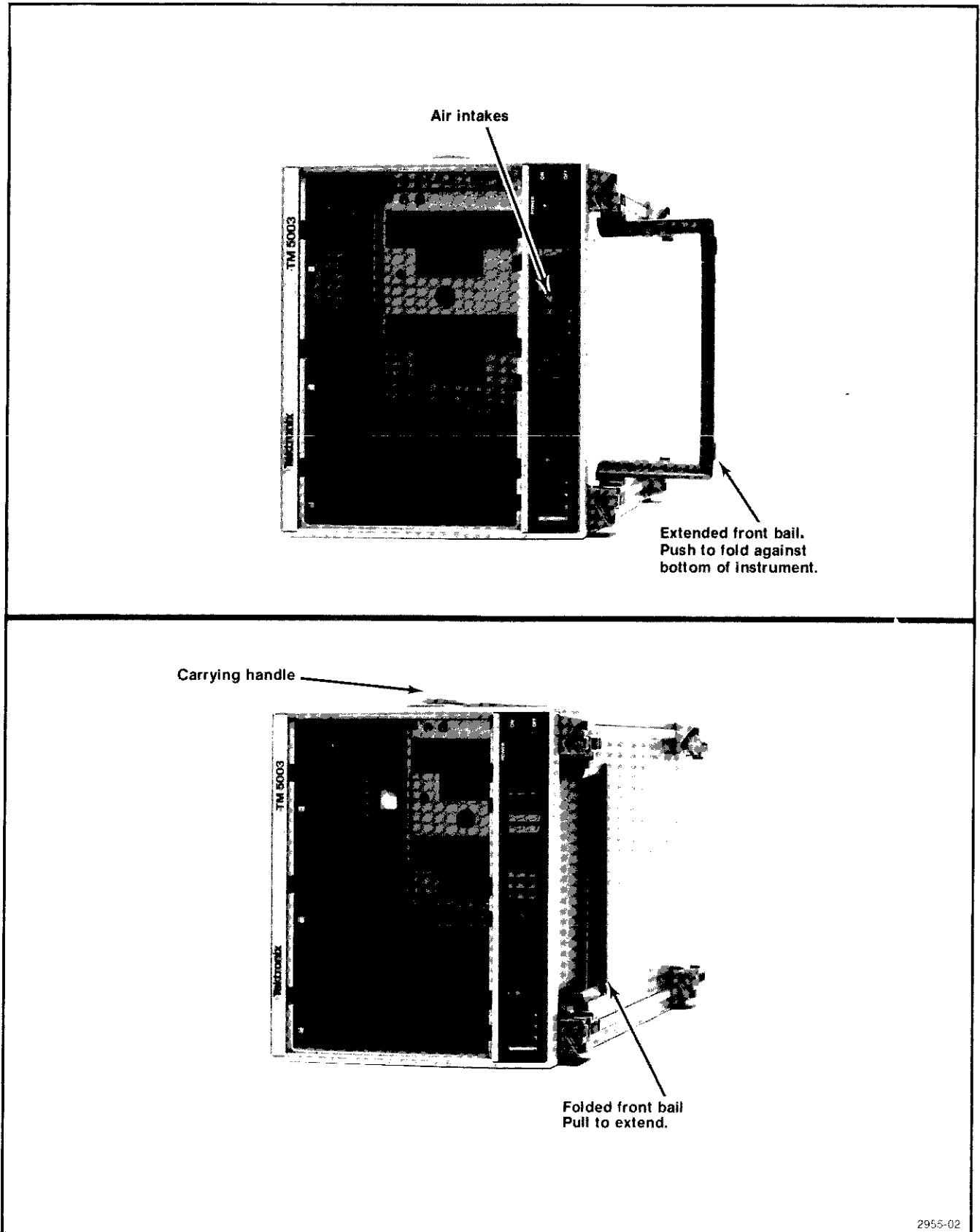

Fig. 2-2. TM 5003 bottom view.

2955-02

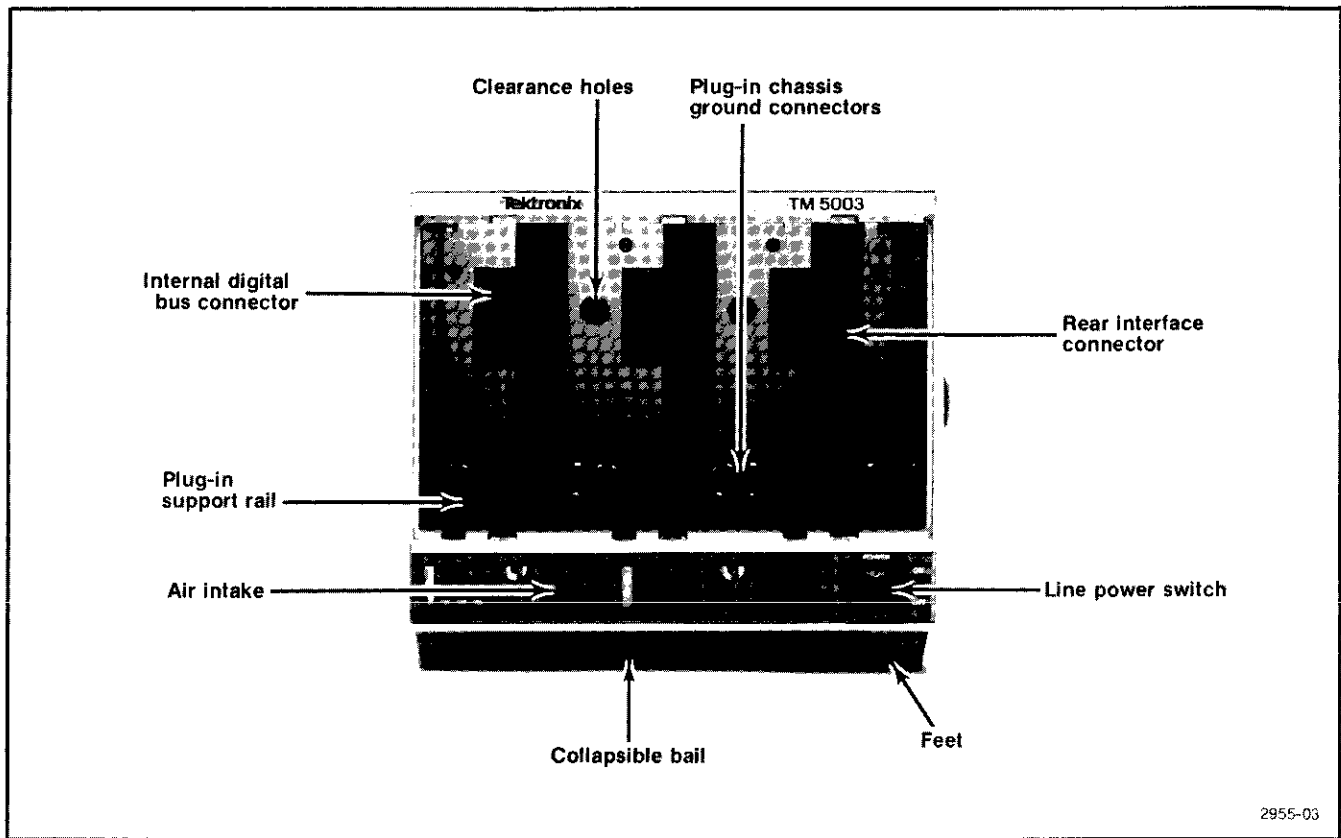

Fig. 2-3. TM 5003 front view.

Save and reuse the package in which your instrument was shipped. If the original packaging is unfit for use or not available, repackage the instrument as follows:

Surround the instrument with polyethylene sheeting to protect the instrument finish. Obtain a carton of corrugated cardboard of the correct carton strength having inside dimensions of no less than six inches more than the instrument dimensions. Cushion the instrument by tightly packing three inches of dunnage or urethane foam between carton and instrument on all sides. Seal the carton with shipping tape or an industrial stapler.

The carton test strength for this instrument is 350 pounds per square inch.

### Stacking and Rackmounting

TM 5003s with their cabinets and feet in place may be stacked on top of each other. Give adequate spacing for the necessary ventilation.

The TM 5003 is designed to be half-rack width. Field conversion kits with slide-out tracks are available to mount one or two TM 5003s or a TM 5003 and other instruments, in a standard 19-inch rack. Vertical space needed is 7 inches.

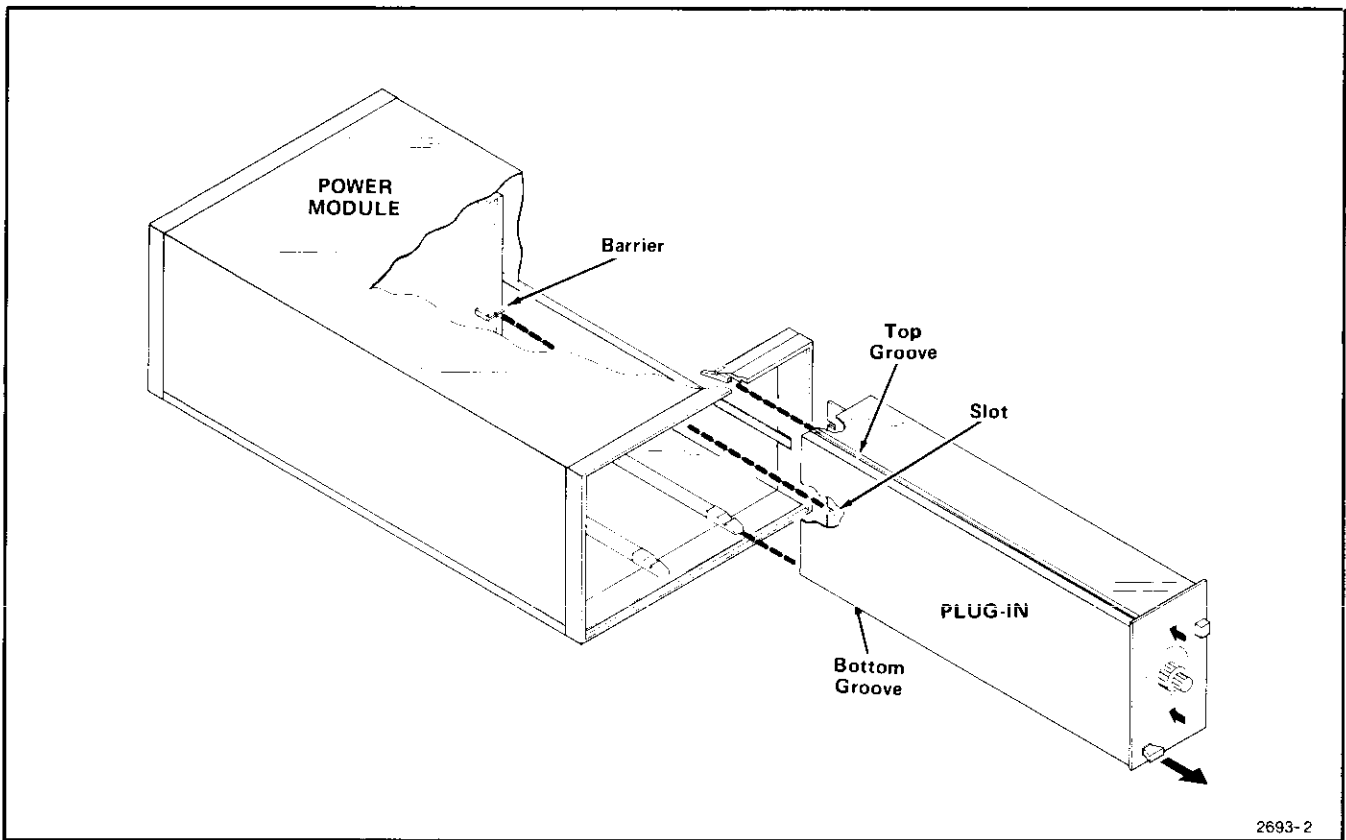

2693-2

Fig. 2-4. Plug-in installation and removal.

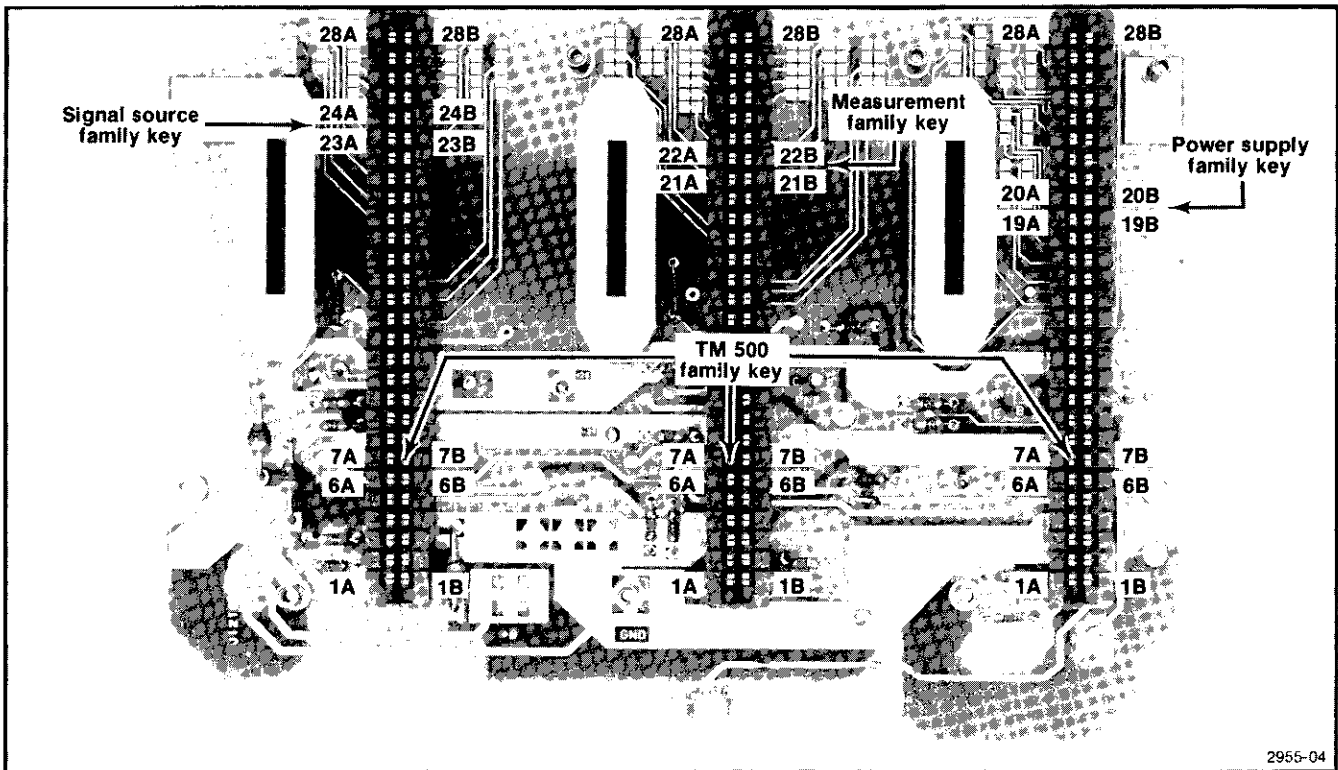

2955-04

Fig. 2-5. Keying assignments for family functions. One of many possible sequence combinations.



# THEORY OF OPERATION

## Introduction

For ease in understanding, this description refers to the schematics located in the pullout pages at the rear of this manual. Also refer to the block diagram located in the pullout pages and the timing diagram in Fig. 3-1. Each block in the block diagram is outlined on the schematics.

The TM 5003 uses a pulse width modulated switching supply for dc voltages. A 60 Hz transformer provides the ac voltages necessary for plug-in operation. Connections to the six plug-in compartments as well as the series pass transistors are shown on schematic .

## Line Selector and 60 Hz Transformer

Ac power is applied to the voltage-select terminals through FL500 and a discrete line filter composed of T1000, L1000 and L1100. Line transients are filtered to ground through C1000 and C1100.

The two primary windings on T500 are connected in parallel for 115 V operation or in series for 230 V operation. Winding taps are provided for various line voltages around the nominal values. The secondaries provide ac voltages to the various plug-in compartments.

## Rectifiers and Filters

The ac line voltage is applied through negative temperature coefficient resistances RT1020 and RT1110 to the rectifier diodes. As these resistances are highest when cold, the surge currents, charging the high voltage capacitors when line voltage is applied, are limited, thus preventing component failure. These resistors then self heat to a low resistance.

In 220 V operation the four diodes function as a bridge rectifier. See Fig. 3-2. When the voltage select circuit is set for 110 V operation only the two series diodes operate. The circuit then becomes a voltage doubler with an output of approximately 350 V dc. The neon bulb in this circuit flashes to indicate when dc voltage is present.

The rectified and filtered dc is applied through L1220 and C1210, a low pass filter, and passes through R1210 and CR1303, to the collector of Q1301.

## 20 kHz Output Stage

The output stage is a half bridge type with proportional base drive. The turns' ratios and phasing of T1430 are such that only a small amount of base drive power is needed to start conduction in either Q1301 or Q1300. Positive feedback from T1430 supplies base current for the remainder of the power cycle. When both base drive transistors, Q1400 and Q1401, (shown on schematic ) are saturated, T1740 is essentially shorted, terminating base current for either output transistor. Output transistors Q1300 and Q1301 alternately conduct at a 20 kHz rate. Their on and off times are adjusted by the regulation circuitry. Diodes CR1300 and CR1301 prevent base to collector current flow in Q1300 and Q1301 at turn off. The base switching action of these transistors is improved by networks C1401 and R1400 for Q1301, and C1411 and R1410 for Q1300. A series resonant filter between the transistors and the output transformer, T1210, is composed of C1320 and L1200. During Q1300 and Q1301 off time, the tank current generated by L1200 and C1320 passes through CR1302 and CR1300.

The 20 kHz output voltage is stepped down to the correct levels by T1210.

Three sets of full wave diode rectifiers are provided for each of the three dc voltage outputs. Schottky diodes are used in the +8 V supply for reduced forward voltage drop. All filters are L-C pi-sections. Bleeder resistors are provided for all filter capacitors.

## Control Logic and Drivers

U1620E and U1620F are inverting amplifiers. Their outputs control the base drive transistors Q1401 and Q1400. Collector voltage for these transistors is applied from the 10 V bus through a center tapped winding on the base drive transformer (T1430). Reverse polarities across Q1401 or Q1400 are prevented by CR1501 and CR1500. When either one or both of these transistors (Q1730, Q1731) are on, either one or both of the output transistors (Q1300, Q1301) are off. The bases of Q1400 and Q1401 are also controlled, through R1511 and R1520, by the collector of Q1650. During power up or power down, the collector of Q1650 goes positive. This action turns Q1401 and Q1400 on to turn the output transistors off. This is necessary as the control circuitry is undefined during power up or power down.

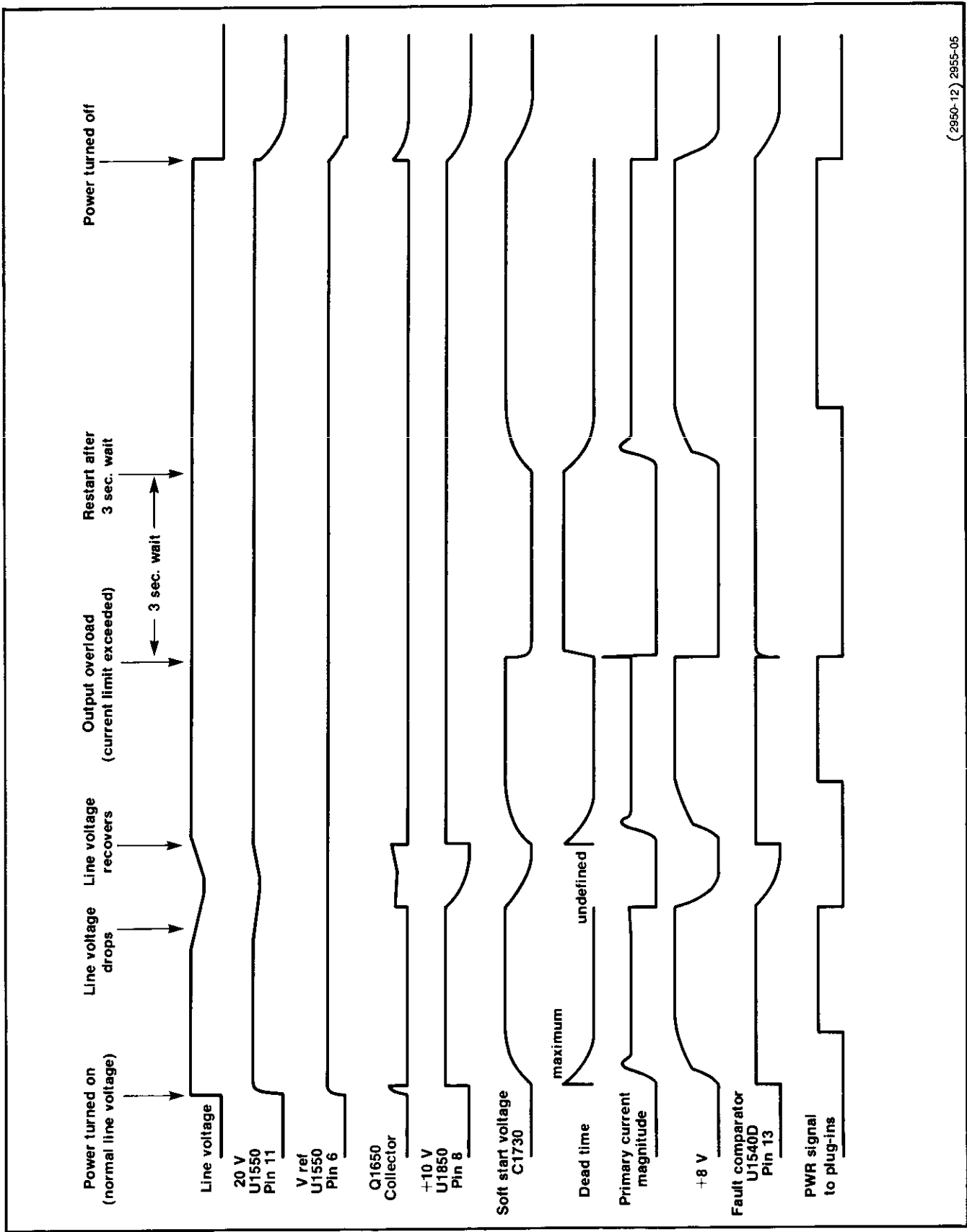

(2950-12) 2955-05

Fig. 3-1. Various waveforms and time relationships for power on, off, fault and low line.

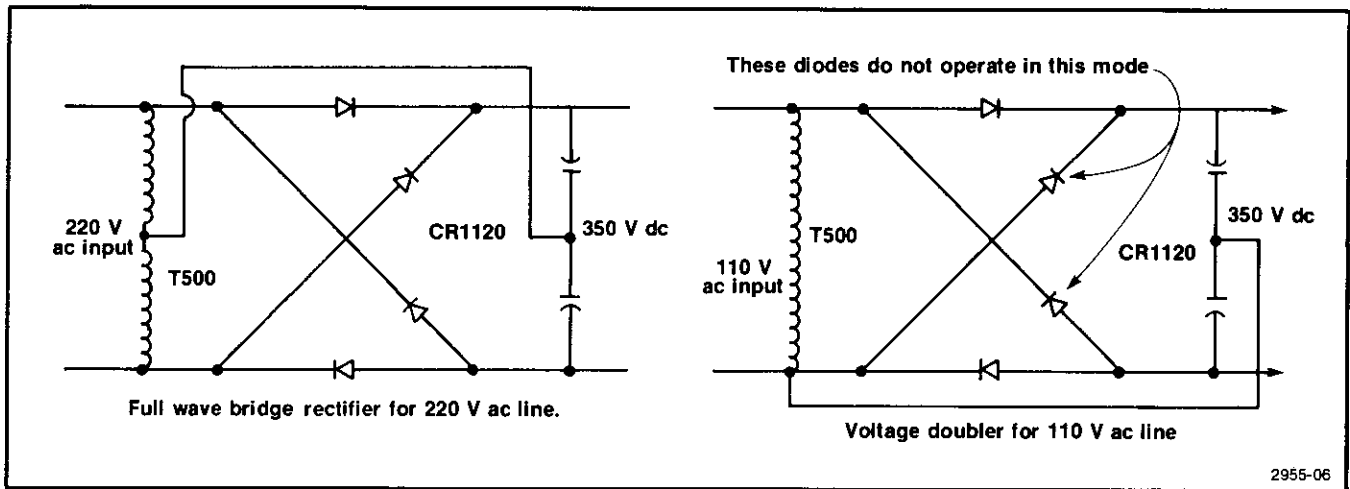

Fig. 3-2. Input line connections for 110 V and 220 V operation.

When pins 1 of U1610A and 13 of U1610B are low, no drive is applied to the output stage. With one gate output high and the other low base drive is applied to one output transistor. Input pins 5 and 10 connect to the wait flip flop, U1720A. Input pins 3 and 12 connect to U1720B, the dead time multivibrator. Input pins 4 and 1 connect to the output of the stop monostable, U1600A. Pins 2 and 9 connect to the complement outputs of the divide by 2 flip flop, U1600B. With any one or all of these inputs high, the output lines are low and no drive is applied to one or both of the output transistors.

The dead time multivibrator circuitry determines the minimum off time of the output transistors. Dead time is necessary to allow one output transistor to completely turn off before the other turns on. At start up the A input (pin 12) of U1720B goes low. This allows U1720B to trigger on the clock signal at the B input (pin 11). The minimum timing period of U1720B, determined by R1610 and C1700, is 5  $\mu$ s. This pulse width is lengthened by C1710, CR1710 and CR1711 as the voltage on C1730 and C1831 is decreased. The pulse width of the power supply output varies for soft start and power limit. When pin 10 of U1720B is high, both output transistors are off.

Dead time or output transistor off time is maximum with C1730 and C1831 discharged and minimum charged. The output power available gradually increases as these capacitors charge during soft start. The soft start prevents high input currents, to capacitors, from damaging circuit components. When pin 6 of the wait multivibrator U1720A goes high for any reason (fault), pin 8 of U1620D goes low discharging C1730 and C1831. Under normal operation, when power is turned on, C1730 and C1831 charge to the voltage at pin 8 of U1620D as determined by R1820 and R1830. This takes approximately 1/2 second.

The power limit control is R1830. For maximum power this control must be in the full clockwise position (maximum resistance). For servicing the control can be adjusted for reduced power output levels. This is accomplished by reducing the resistance of R1830, limiting the voltage across C1730 and C1831.

The purpose of flip flop U1600A is to vary the on time of the output transistors consistent with the output voltage level. When pin 6 of U1600A goes high, pin 1 also goes high. This action shuts down the base drive circuitry, reducing power output. The length of time pin 6 remains high is controlled by the Output Regulator circuitry. The rising portion of the waveform at pin 4 of U1600A resets the flip flop for a low condition at pin 1.

Flip flop U1600B divides the 40 kHz output waveform from U1720B to 20 kHz. The pulse from the dead time multivibrator, U1720B, is applied to the clock terminal (pin 11) of U1600B. The Q terminal of U1600B is connected to its D input. The multivibrator U1600B toggles on the rising edges of the dead time multivibrator (U1720B) output.

## Output Regulator



The 40 kHz clock oscillator, which provides the basic timing necessary for the control circuitry, is composed of U1620A, B and C. Feedback occurs from pin 6 of U1620C and pin 4 of U1620B to pin 1 of U1620A. The output voltage at pin 4 of U1620B is high for about 4  $\mu$ s and low about 21  $\mu$ s. This nonsymmetrical duty cycle is accomplished by CR1720 and is necessary for proper operation of U1720B.

The positive going output pulses from the clock oscillator charge C1450 to about 9.5 V through CR1610. When the positive pulse at pin 4 of U1620B drops to 0 V, C1450 discharges through R1452 causing a falling ramp waveform of about 50 mV peak to peak amplitude to appear at pin 4 of U1540A.

The +8 V from the power supply output is applied to voltage adjust potentiometer R1530. The voltage on pin 4 of U1540A is +7.15 V, the reference voltage generated in U1550. Also, on pin 4 is a negative going 40 kHz ramp as previously described. This ramp is ac coupled to pin 4 through C1451. On the rising edge of each clock pulse, the ramp goes positive rapidly. Pin 2 of U1540A is low. At some point, during the ramp decay, the ramp voltage and the feedback voltage at pin 5 are equal. At this point, pin 2 goes high, terminating the drive pulse through the logic circuitry. The higher the output voltage, the earlier in the ramp cycle pin 2 goes high.

### Overvoltage and Overcurrent Detectors

Pin 11 of U1540D, the negative overvoltage detector, connects to a voltage divider between the -26 V supply and the reference +7.15 V. Should pin 11 go more negative than pin 10, pin 13 goes low shutting off the output. The input of U1540D is protected from a negative voltage by CR1840.

Primary current in output transformer T1210 flows through T1000 . The secondary voltage of T1000 is proportional to the primary current. The secondary voltage of T1000 is rectified by CR1511, CR1512, CR1502 and CR1510 and terminated in R1510. When the primary current in T1000 exceeds a predetermined limit, the voltage at pin 6 of U1540B exceeds the 7.15 V reference at pin 7. Pin 1 goes low turning off the output transistors via the wait multivibrator.

The +26 V is applied through R1462 and CR1451 to pin 8 of U1540C, the positive overvoltage detector. The +8 V is also applied through R1453 and CR1450 to pin 8. Pin 9 of comparator U1540C connects to the +7.15 V reference voltage. If pin 8 of U1540C goes more positive, pin 14 goes low. This action triggers U1720A the wait multivibrator, turning the supply off for about 3 seconds. The soft start cycle follows. The negative going pulse from U1540C is time delayed by R1840 and C1830.

When +10 V is applied at power up, C1630 holds pin 3 (clear) of U1720A low for a short period. This overrides the A and B inputs of U1720A, causing pin 6, the Q output, to remain low. Overvoltage or overcurrent causes a low at pin 4 of U1720A causing one high level pulse of about 3 seconds duration at pin 6. This 3 second pulse duration time is

determined by C1620 and R1720. The clock pulse retriggers U1720A if the fault persists. The purpose of CR1730 is to discharge C1630 when ac power is removed from the supply. Noise from the limit circuitry is filtered by C1830.

### Control Circuit Regulator

The 16 V ac winding on T500 is applied through F1660 to rectifier diode CR1561, which charges filter capacitor C1761 to approximately +20 V. The +20 V is applied to voltage regulator U1550. This regulator outputs two voltages: +10 V which is used throughout the entire supply and +7.15 V, a reference voltage, at pin 6.

The line detector circuitry is composed of CR1560, C1851, Q1650 and associated components. When normal line voltage is applied, the voltage across C1851 is approximately 20 V. Transistor Q1650 is on and pin 2 of U1550 is about 0.2 V above ground. If about two cycles of line voltage are missed or the line voltage goes low Q1650 no longer saturates. The collector of Q1650 rises, disabling the series pass transistor located internally in U1550. The +10 V is removed from the power supply during line drop out to prevent discharge of the main filter capacitors in the output stage. Positive feedback is provided through R1750 to the base of Q1650 to improve the switching action.

The PWR signal circuitry (U1850) provides a signal to each compartment in the power module to give power supply status information to the plug-ins. See the rear interface information part of the Maintenance section (Section 50 of this manual for timing information.

Pin 7 of U1850 goes low when the rising voltage at pins 2 and 6 reaches 2/3 of the value of the voltage connected to pin 4 (+10 V). Pin 7 of U1850 connects to the base of Q1125 . This transistor inverts the signal from pin 7 to the plug-in compartments.

When the line power goes low or off, pin 13 of U1550 goes low. This action raises pin 7 of U1850 turning off the PWR signal. Pin 7 of U1720A is also low during the 3 second wait state. The cathode of CR1830 is pulled low which turns off the PWR signal.

The soft start feature also controls the PWR signal. This is accomplished through R1821.

When a fault occurs, pin 6 of U1720A goes high. When the fault is removed pin 6 of U1720A goes low causing pin 8 of U1620D to go high. As the voltage at the junction of R1821 and R1820 goes high pin 6 and 2 of U1860 also go high causing the PWR signal to go high.



**Main Interface**



The various ac and dc supply voltages as specified are available at the rear interface connectors for each plug-in

compartment. Each compartment has a pnp and an npn transistor intended as series pass elements. Connecting pins to these elements are shown on the schematic.



## **WARNING**

THE FOLLOWING SERVICING INSTRUCTIONS ARE FOR USE BY QUALIFIED PERSONNEL ONLY. TO AVOID PERSONAL INJURY, DO NOT PERFORM ANY SERVICING OTHER THAN THAT CONTAINED IN OPERATING INSTRUCTIONS UNLESS YOU ARE QUALIFIED TO DO SO.





# CALIBRATION

## PERFORMANCE CHECK PROCEDURE

### Introduction

This procedure checks the Electrical Performance Requirements as listed in the Specification section in this manual. Perform the internal adjustment procedure if the instrument fails to meet these checks. If recalibration does not correct the discrepancy, circuit troubleshooting is indicated. Also, use this procedure to determine acceptability of performance in an incoming inspection facility.

Performance check may be done at any ambient temperature between 0°C and +50°C.

### Test Equipment Required

The test equipment listed in Table 4-1, or equivalent, is suggested to perform the performance check in the adjustment procedure.

### WARNING

*Dangerous voltages are present inside this instrument. Exercise caution as this procedure requires removal of the power supply cover.*

### Test Loads For The Performance Check Procedure

To do the performance check procedure the supplies must be loaded. Maximum load for the +8 V supply is 9A and for the 26 V supplies 3A. Maximum dissipation from these loads is 72W and 78W. The total power draw from any combination of the +8 V and  $\pm 26$  V supplies is 90W or 30W per compartment. Figure 4-1 shows suggested loads.

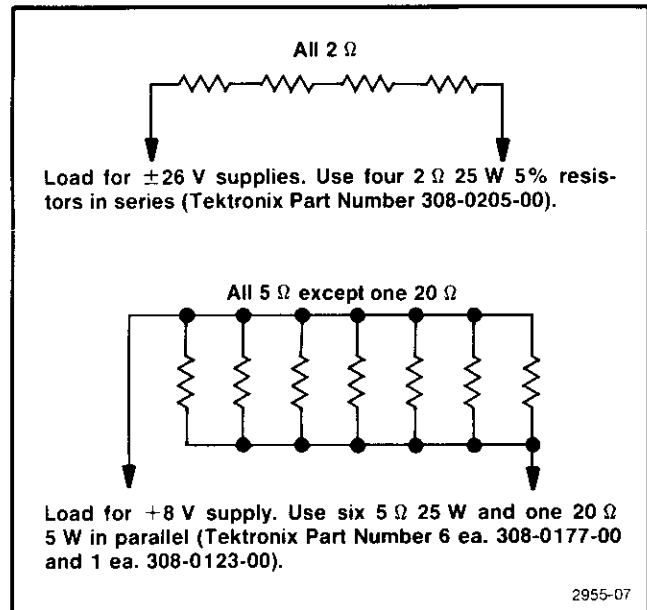

Fig. 4-1. Possible loads for use in performance check procedure. See text.

Any combinations of resistors with sufficient dissipation is satisfactory. Connect the loads to the instrument with not over 1.5 feet, for each lead, of 12 AWG for the 8 V load and 16 AWG for the 26 V load. The ground lead should not exceed 1.5 feet of length and must be #12 AWG or larger. For convenience, use quick disconnect terminals to connect the loads to the voltage buses in the instrument (Tektronix Part Number 131-1563-00).

**Table 4-1  
SUGGESTED TEST EQUIPMENT**

| Description                  | Minimum Requirements     | Performance Check Step | Adjustment Procedure Step | Recommended Equipment                                  |
|------------------------------|--------------------------|------------------------|---------------------------|--|
| Digital Multimeter           | + 8 V, - 26 V,<br>+ 26 V | All                    | 1                         | Tektronix<br>DM 505                                    |
| Test Load Unit               |                          | All                    |                           | See text   |
| Variable Voltage Transformer | 600 VA capability        | All                    | 1                         | VARIAC W10MT3W<br>Autotransformer<br>General Radio USA |

**CAUTION**

*As considerable heat is generated in the test loads do not apply power longer than necessary to complete tests.*

**1. Check +26 Vdc**

a. Connect the test equipment as shown in Fig. 4-2. Adjust the line voltage to the TM 5003 for 10% below the nominal line voltage.

b. Set the load for maximum.

c. CHECK—that the dvm reads from +23.7 V to +28.3 V.

d. Change the line voltage to 7% above the nominal.

e. Remove the load from the supply.

f. Set the +8 V load for maximum.

g. CHECK—that the supply reads from +23.7 V to +28.3 V.

h. Remove the connections to the +26 V bus for the next step.

**2. Check -26 Vdc**

a. Connect the test equipment as shown in Fig. 4-2. Adjust the line voltage to the TM 5003 for 10% below the nominal line voltage.

b. Set the -26 V load for maximum.

c. CHECK—that the dvm reads from -23.7 V to -28.3 V.

d. Change the line voltage to 7% above the nominal.

e. Remove the -26 load from the supply.

f. Set the +8 V load for maximum.

g. CHECK—that the supply reads from -23.7 V to -28.3 V.

h. Remove the connections to the -26 V bus for the next step.

**3. Check +8 Vdc**

a. Connect the test equipment as shown in Fig. 4-2. Adjust the line voltage to the TM 5003 for 10% below the nominal line voltage.

b. Set the +8 V load for maximum.

c. CHECK—that the dvm reads from +7.6 V to +8.5 V.

d. Change the line voltage to 7% above the nominal.

e. Remove the load from the supply.

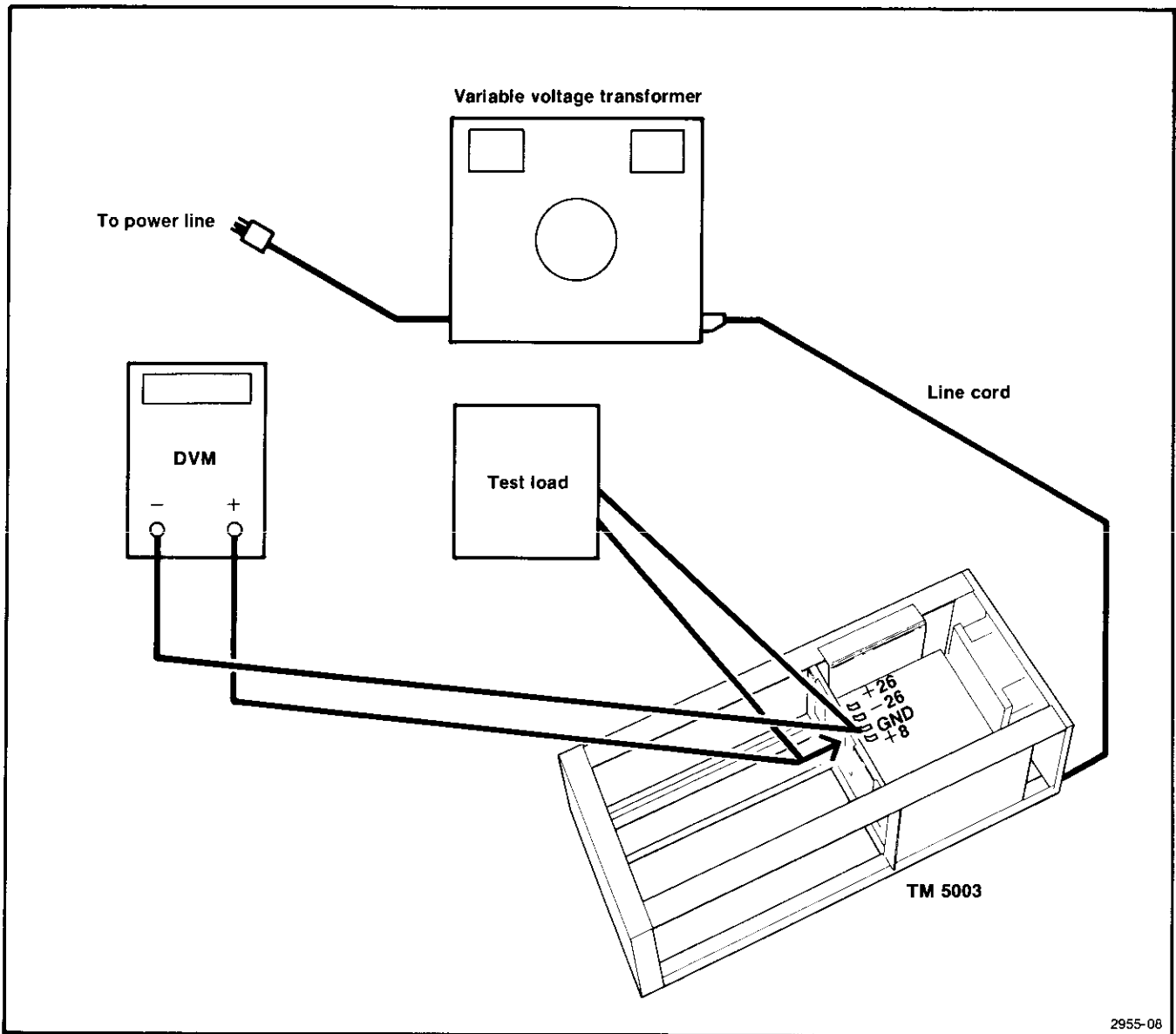

2955-08

Fig. 4-2. Test setup for performance check steps 1, 2 and 3 and location of connections for adjustment step 1.

f. CHECK—that the supply reads from +7.6 V to +8.5 V.

h. This completes the Performance Check Procedure.

g. Remove all connections.





# INTERNAL ADJUSTMENT PROCEDURE

## Introduction

This procedure should be performed if the instrument fails to meet the performance requirements of the electrical characteristics listed in the specification section of this manual. To ensure continued instrument accuracy, it is recommended that adjustment be performed every 1000 hours of operation or every 6 months if used infrequently. Adjustment is also recommended following instrument repair or modification. Adjustments must be made in an ambient temperature of  $+20^{\circ}\text{C}$  to  $+30^{\circ}\text{C}$ .

## Services Available

Tektronix, Inc. provides complete instrument repair and adjustment at local field service centers and at the factory service center. Contact your local Tektronix field office or representative for further information.

## Test Equipment Required

Test equipment (or equivalent) listed in Table 4-1 is required for adjustment of the TM 5003. Specifications given for the test equipment of the minimum necessary for accurate adjustment. All test equipment is assumed to be correctly calibrated at operating within specification. If other test equipment is substituted, the calibration setup may need to be altered to meet the requirements of the equipment used.

## Adjustment Access

Remove the top cover to gain access to the  $+8\text{ V}$  and ground buses and the adjustment. Figure 4-3 shows the adjustment locations.

## Power Limit Adjustment

The Pwr Lim adjustment R1830 is used for troubleshooting only. Before commencing calibration make certain this adjustment is fully ccw.

### 1. Adjust 8 V Adj

a. Connect the dmm to the  $+8\text{ V}$  and Gnd terminals as shown in Fig. 4-2. The voltage bus location is shown in Fig. 4-3.

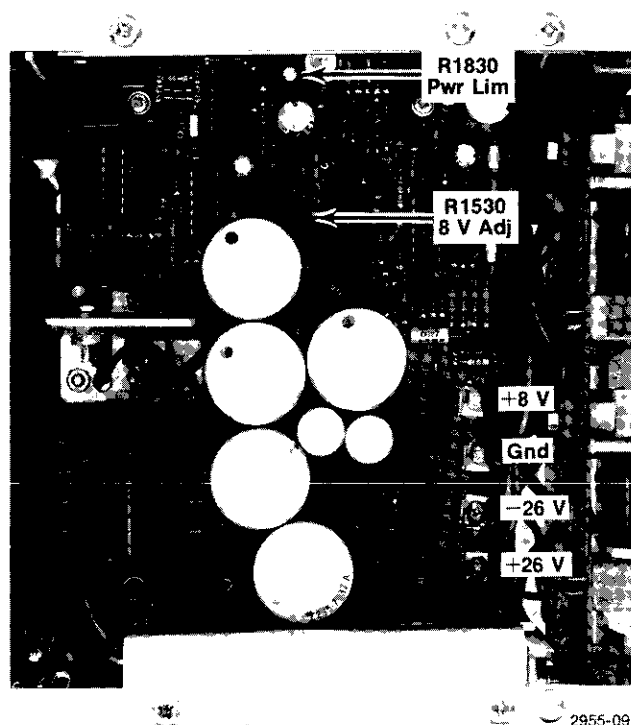

Fig. 4-3. Locations of voltage buses and adjustments.

- b. Set the line voltage to nominal for the selected range.
- c. CHECK—for a reading of 8.2 V.
- d. ADJUST—R1530, 8 V Adj, for a dvm reading of 8.2 V.
- e. Remove all connections.
- f. This completes the internal adjustment procedure.



# MAINTENANCE

## Preparation For Use

Figure 5-1 illustrates the line cord options available for the TM 5003. Fuse data is printed on the rear panel and in the specification section of this manual. After determining the nominal line voltage, refer to Fig. 5-2 for proper jumper positions. Select the line voltage closest to the nominal for the range used.

## Static Sensitive Components



*Static discharge can damage any semiconductor component in this instrument.*

This instrument contains electrical components that are susceptible to damage from static discharge. See Table 5-1 for relative susceptibility of various classes of semiconductors. Static voltages of 1 kV to 30 kV are common in unprotected environments.

Observe the following precautions to avoid damage:

1. Minimize handling of static-sensitive components.

2. Transport and store static-sensitive components or assemblies in their original containers, on a metal rail, or on conductive foam. Label any package that contains static-sensitive assemblies or components.
3. Discharge the static voltage from your body by wearing a wrist strap while handling these components. Servicing static-sensitive assemblies or components should be performed only at a static-free work station by qualified service personnel.
4. Nothing capable of generating or holding a static charge should be allowed on the work station surface.
5. Keep the component leads shorted together whenever possible.
6. Pick up components by the body, never by the leads.
7. Do not slide the components over any surface.
8. Avoid handling components in areas that have a floor or work surface covering capable of generating a static charge.

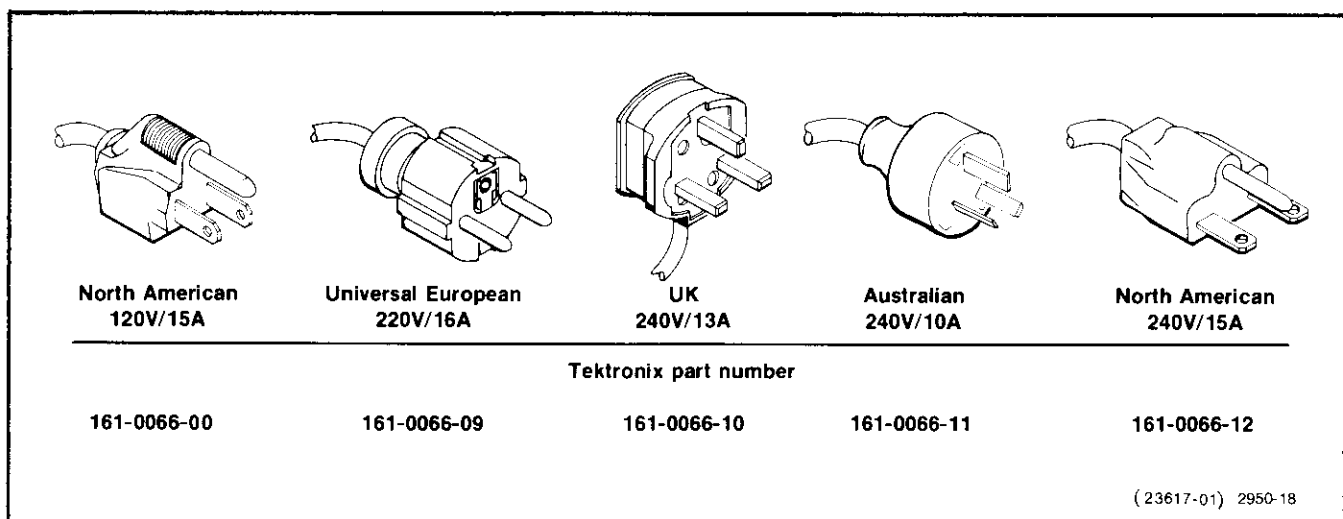

Fig. 5-1. Line cord options for the TM 5003.

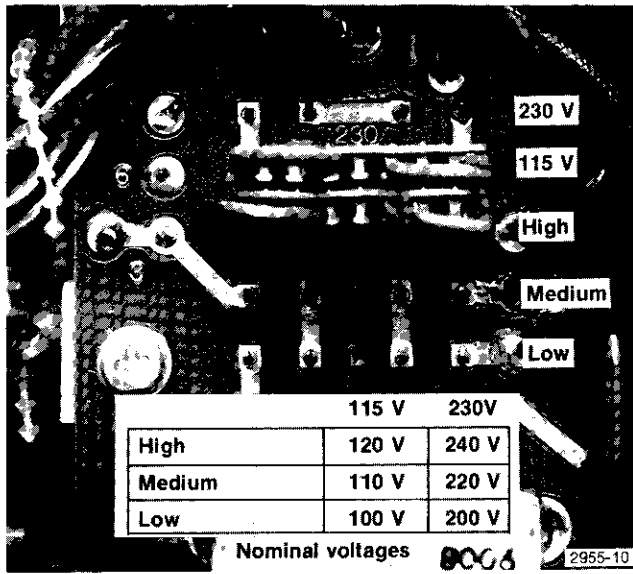

Fig. 5-2. Line voltage jumper positions.

9. Use a soldering iron that is connected to earth ground.
10. Use only special antistatic suction type or wick type desoldering tools.

Table 5-1  
RELATIVE SUSCEPTIBILITY  
TO STATIC DISCHARGE DAMAGE

| Semiconductor Classes   | Relative Susceptibility Levels <sup>a</sup> |
|---|---|
| MOS or CMOS microcircuits or discretes, or linear microcircuits with MOS inputs. (Most Sensitive) | 1   |
| ECL   | 2   |
| Schottky signal diodes  | 3   |
| Schottky TTL  | 4   |
| High-frequency bipolar transistors  | 5   |
| JFETs   | 6   |
| Linear microcircuits  | 7   |
| Low-power Schottky TTL  | 8   |
| TTL (Least Sensitive)   | 9   |

<sup>a</sup>Voltage equivalent for levels:

- |                  |                  |                         |
|------------------|------------------|-------------------------|
| 1 = 100 to 500 V | 4 = 500 V        | 7 = 400 to 1000 V(est.) |
| 2 = 200 to 500 V | 5 = 400 to 600 V | 8 = 900 V               |
| 3 = 250 V        | 6 = 600 to 800 V | 9 = 1200 V              |

(Voltage discharged from a 100 pF capacitor through a resistance of 100 ohms.)

### Cleaning

This instrument should be cleaned as often as operating conditions require. Loose dust accumulated on the outside of the instrument can be removed with a soft cloth or small brush. Remove dirt that remains with a soft cloth dampened in a mild detergent and water solution. Do not use abrasive cleaners.

The best way to clean the interior is to blow off the accumulated dust with dry, low-velocity air (approximately 5 lb/in<sup>2</sup>) or use a soft brush or cloth dampened with a mild detergent and water solution.



*Circuit boards and components must be dry before applying power.*

### Obtaining Replacement Parts

Electrical and mechanical parts can be obtained through your local Tektronix Field Office or representative. However, it may be possible to obtain many of the standard electronic components from a local commercial source. Before purchasing or ordering a part from a source other than Tektronix, Inc., check the Replaceable Electrical Parts list for the proper value, rating, tolerance, and description.

#### NOTE

*When selecting replacement parts, remember that the physical size and shape of a component may affect its performance in the instrument.*

Some parts are manufactured or selected by Tektronix, Inc., to satisfy particular requirements or are manufactured for Tektronix, Inc., to our specifications. Most of the mechanical parts used in this instrument have been manufactured by Tektronix, Inc. To determine the manufacturer, refer to the Replaceable Parts list and the Cross Reference index, Mfr. Code Number to Manufacturer.

When ordering replacement parts from Tektronix, Inc., include the following information:

1. Instrument type and option number.
2. Instrument serial number.
3. A description of the part (if electrical, include complete circuit number).
4. Tektronix part number.

## Soldering Techniques

### WARNING

To avoid electric-shock hazard, disconnect the instrument from the power source before soldering.

The reliability and accuracy of this instrument can be maintained only if proper soldering techniques are used when repairing or replacing parts. General soldering techniques which apply to maintenance of any precision electronic equipment should be used when working on this instrument. Use only 60/40 rosin-core, electronic grade solder. The choice of soldering iron is determined by the repair to be made.

When soldering on circuit boards or small wiring, use only a 15 watt, pencil type soldering iron. A higher wattage soldering iron can cause the etched circuit wiring to separate from the board base material and melt the insulation from small wiring. Always keep the soldering iron tip properly tinned to ensure the best heat transfer to the solder joint. Apply only enough heat to remove the component or to make a good solder joint. To protect heat sensitive components, hold the component lead with a pair of long-nose pliers between the component body and the solder joint. Use a solder removing wick to remove excess solder from connections or to clean circuit board pads.

## Semiconductors

To remove in-line integrated circuits use an extracting tool. This tool is available from Tektronix, Inc.; order Tektronix Part Number 003-0619-00. If an extracting tool is not available, use care to avoid damaging the pins. Pull slowly and evenly on both ends of the integrated circuit. Try to avoid disengaging one end before the other end.

## Multipin Connectors

The pin connectors used to connect the wires to the interconnecting pins are clamped to the ends of the wires. To replace damaged multi-pin connectors, remove the old pin connector from the holder. Do this by inserting a scribe between the connector and the holder and prying the connector from the holder. Clamp the replacement connector to the wire. Reinstall the connector in the holder.

If the individual end lead pin connectors are removed from the plastic holder, note the order of the individual wires for correct replacement in the holder. For proper replacement see Fig. 5-3.

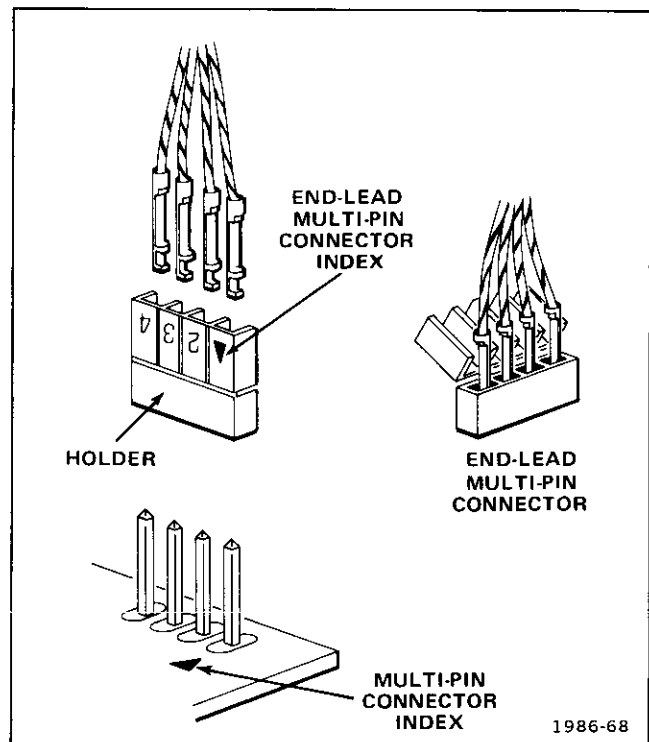

Fig. 5-3. Orientation and disassembly of multipin connectors.

## Instrument Disassembly

### WARNING

Use caution when operating this instrument with the side panels removed as dangerous voltages are present.

To remove the top, bottom and side panels, remove the four screws attaching the feet to the rear of the instrument and slide the panels to the rear. See Fig. 5-4. To remove the interface circuit board, remove the plug-in guide rails and air baffles shown in Fig. 5-5. Next remove the interface circuit board support by removing the screws shown in Fig. 5-6. Before removing the main interface circuit board, make certain the connections to the board are either unplugged or unsoldered. Remove the two screws holding the board to the mainframe. To remove the rear panel, remove the four screws shown in Fig. 5-4. After these screws are removed, the rear panel may be laid aside. To remove the dc power supply primary board remove the screws shown in Fig. 5-7 and Fig. 5-8. See Fig. 5-9 to remove the secondary board. Fig. 5-10 also shows the location of the PNP series pass transistors. The NPN series pass transistors are shown on Fig. 5-11 after removal of the dc power supply primary board. Fig. 5-9 and Fig. 5-10 also show primary power transformer removal.

**WARNING**

*Dangerous voltages may be present on the filter capacitors on the dc power supply board for several minutes after line voltage removal.*

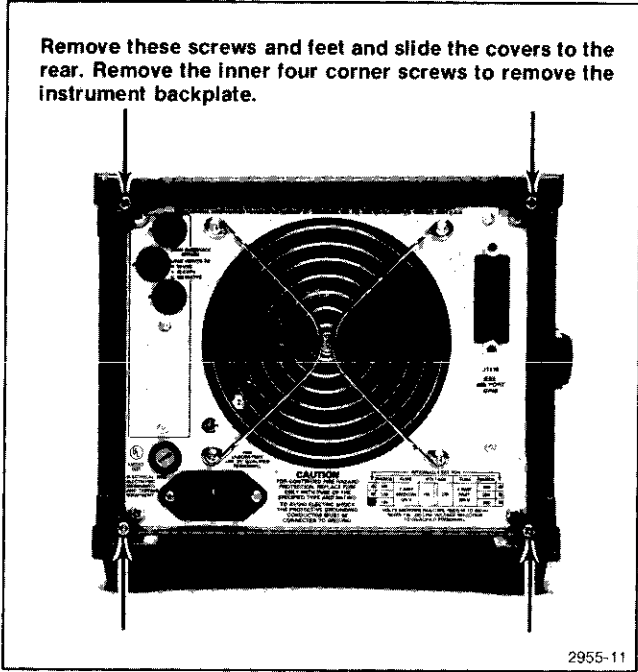

Fig. 5-4. Rear view of TM 5003.

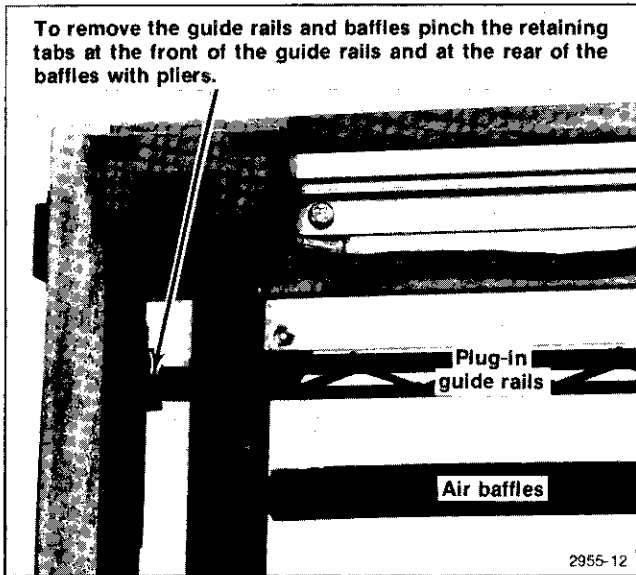

Fig. 5-5. Guide rail and air baffle removal.

When reinstalling the connections to the series-pass transistors, make certain the connections are correct.

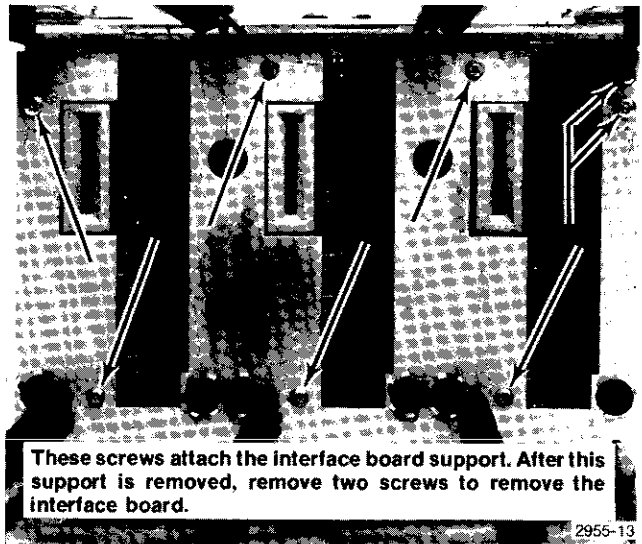

Fig. 5-6. Removal of interface circuit board.

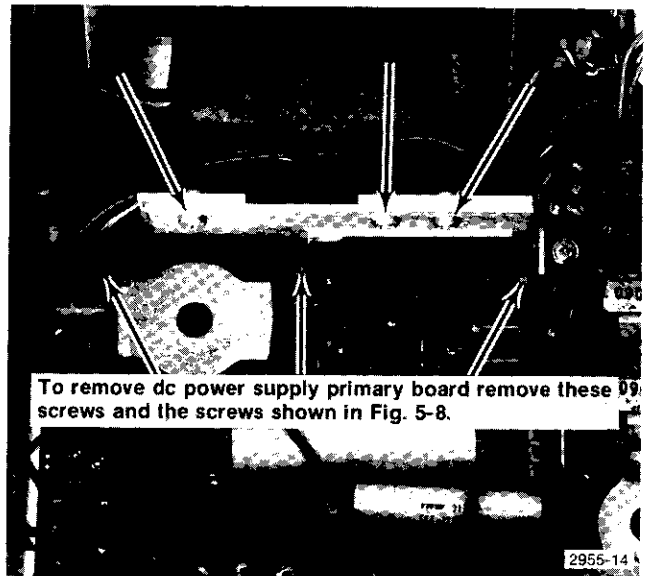

Fig. 5-7. Removal of dc power supply primary board.

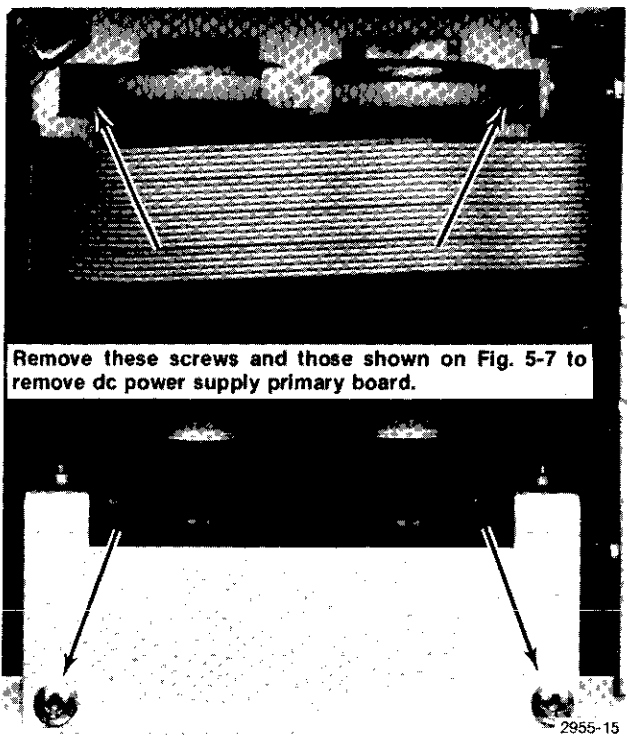

Fig. 5-8. Partial dc power supply primary board removal.

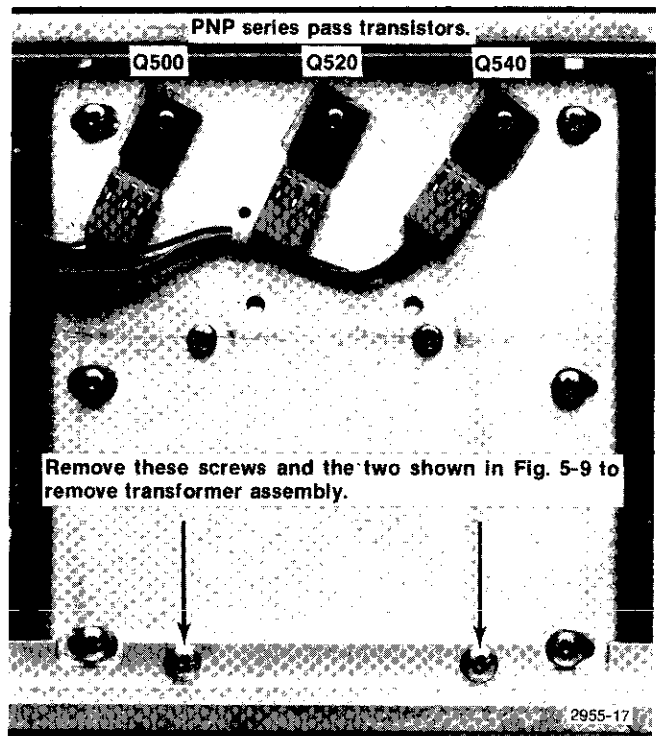

Fig. 5-10. Location of PNP series pass transistors and partial transformer removal.

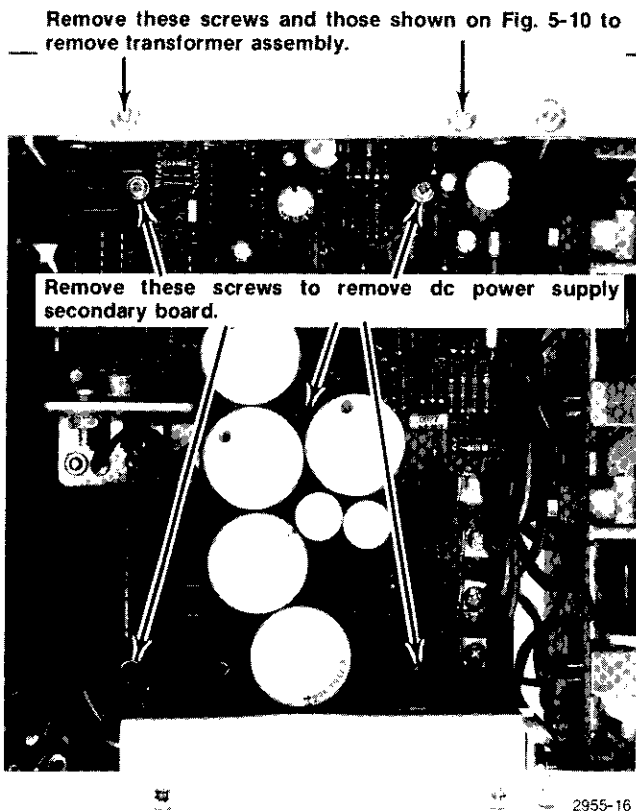

Fig. 5-9. Secondary board and partial primary transformer removal.

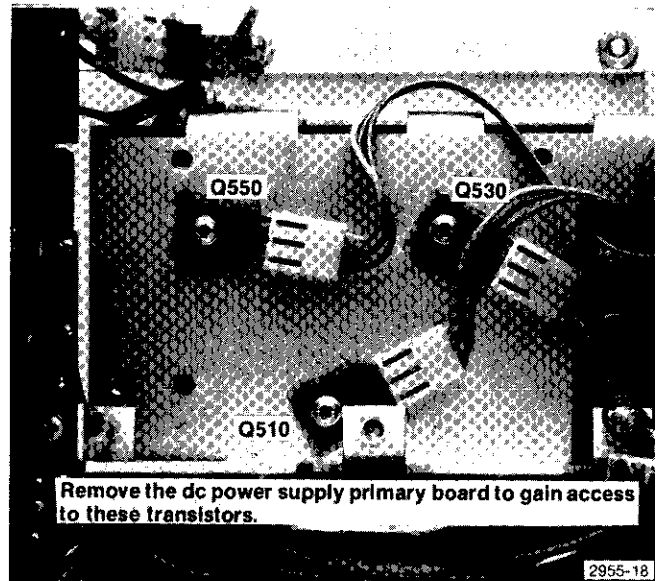

Fig. 5-11. NPN series pass transistors.

### Circuit Troubleshooting

To help locate a fault in the dc power supply, first disconnect P1463. The location of this plug on the interface board may be determined from the parts location grids located in the pullout pages at the rear of this manual. Make certain the line selector is properly set. Connect the power module to a variable voltage transformer. Slowly apply line voltage to the power module. Observe the indicator lamp DS1320. The location of this lamp may be determined from the parts location grids, also. If the lamp flashes at a regular rate, the high voltage (300 VDC) supply is probably operating properly. Turn off the line power. Turn the PWR LIM (R1830)

fully ccw. The location of this control is shown in the parts location grid. Replace P1463. Connect a dVm across the 8 V bus. Apply ac line power at the nominal line voltage to the power module. Slowly turn the PWR LIM control R1830 clockwise and observe the dVm reading. The Dvm should read from about 7.5 V to about 8.5 V when R1830 is fully cw. Next adjust the +8 V ADJ, R1530, for exactly 8.20 V at no load with nominal line voltage. Next check the voltage across R1510, the current sense resistor. This should be from about 0.2 V to about 0.4 V. Verify the current limit by shorting out any of the voltage buses and noting the recovery of the supply after about a 3 second delay. Check the +26 V outputs for limits within specification.



# REAR INTERFACE INFORMATION

## PWR Indicator

A signal out on pin 6B on the rear interface connector provides the plug-ins with power supply status information. See Fig. 5-12. This signal is TTL compatible with  $\leq 30 \Omega$  output impedance. The maximum plug-in load per compartment is one standard TTL load. No pullup resistors are allowed. The maximum capacitance per compartment must not exceed 150 pF. The fall and rise time ( $t_f$  and  $t_r$ ) is  $\leq 5 \mu\text{s}$ .

## Pin Assignments

Figure 5-3 shows the pin assignments for the power module outputs. Pins 14 through 28 are reserved for signal connections. See sections 2 and 6 of this manual and the plug-in manuals for further information.

Figure 5-4 shows the pin assignments for the GPIB rear panel connector.

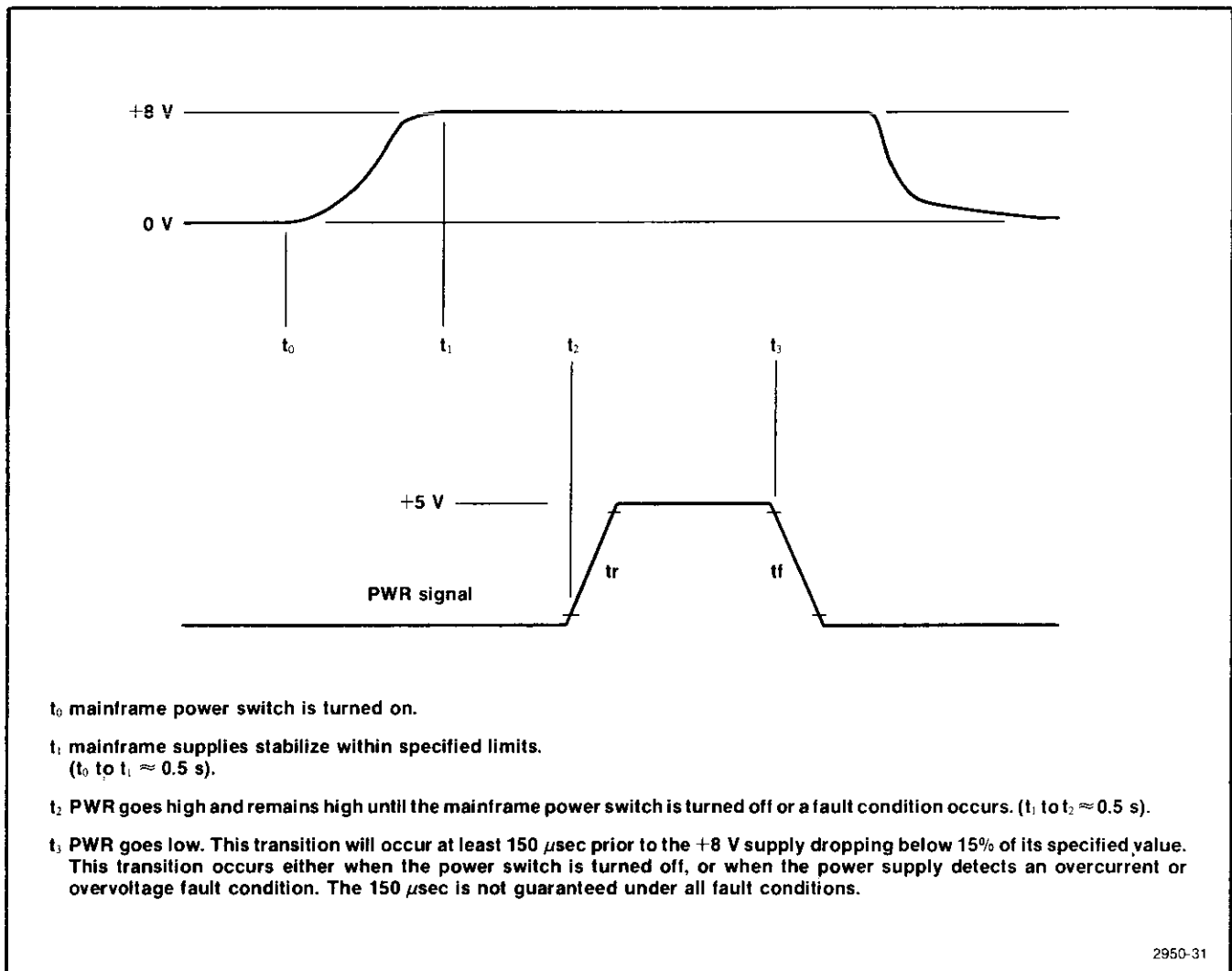

Fig. 5-12. PWR signal timing diagram.

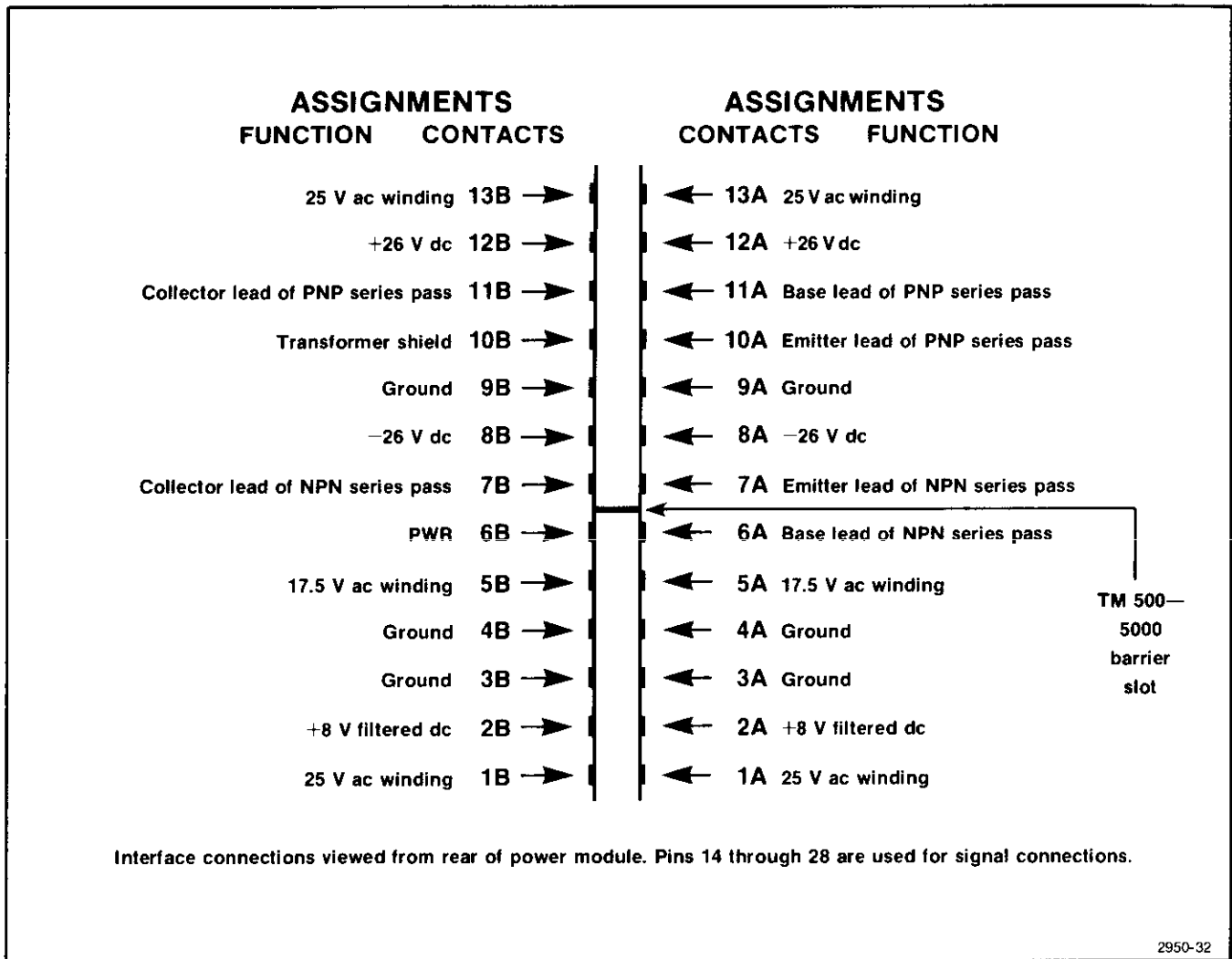

Fig. 5-13. Rear interface connector assignments.

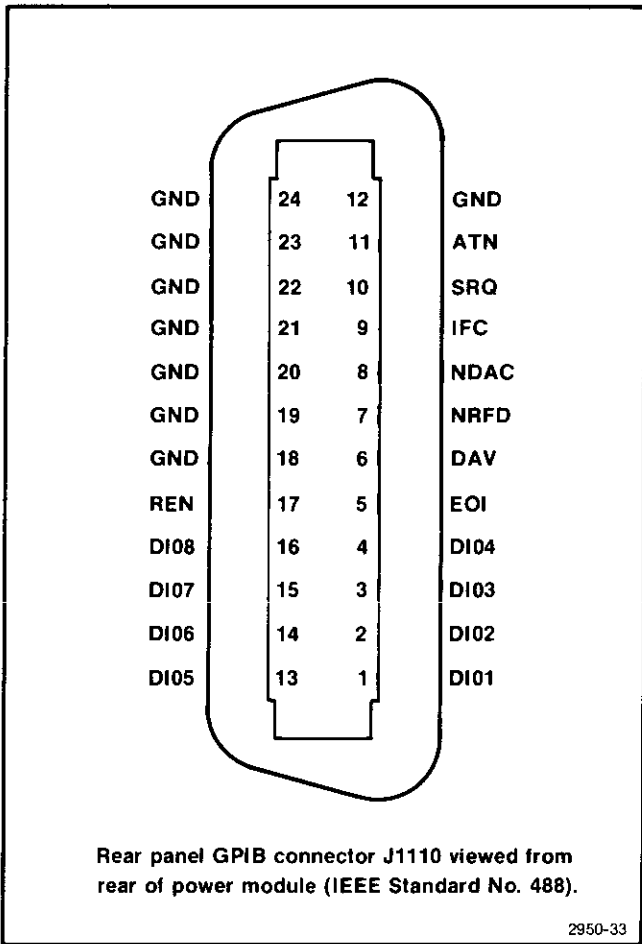

Fig. 5-14. Rear panel GPIB connector J1110 viewed from rear of power module (IEEE Standard No. 488).



# OPTIONS

## Introduction Option 02

This factory installed option adds 25-mil square pin connectors to the rear of the interconnecting jacks at all pins from 14A and B to pins 28A and B. This option also adds three bnc connectors and one 25-pin connector to the rear panel. These connectors are not prewired in order to give as much flexibility as possible. Prepared jumpers, coax cables, and interconnection jack barriers are included in the TM 5003.

## System Design Directions

1. Plan the plug-in location in the mainframe based on operator convenience as well as interface connections.
2. Plan the wiring between interconnecting jacks and to the rear panel connectors before starting assembly. A mating rear panel 25-pin connector is provided for external cabling.

### NOTE

*There are no pin assignments for the rear panel connectors, due to the great variety of possible connections.*

*When high frequency or fast digital signals are involved, plan the wiring to minimize crosstalk. Make allowance for possible auxiliary ground connections.*

*The 25-pin rear panel connector may be easier to connect if it is removed from the rear panel and remounted after connections are made. Remove the top rear cabinet piece for ease of access.*

3. Pin assignments for individual plug-ins will be found in the appropriate instruction manual.
4. Install an interconnection jack barrier at the appropriate location on the interconnection jack. Refer back to operating instructions for keying assignments for family functions.

5. Select and install the wires (hookup or coaxial cable) following the guidelines in the Wire Use part of these instructions.

6. Wires or cables which may be at large potential differences should be dressed or bundled so as to avoid contact. Keep all interface wiring away from the power module primary line wiring.



*Maximum input voltage is  $\leq 60$  Vdc or  $\leq 42.4$  Vdc peak to peak. Limit input power to  $\leq 150$  W per connection.*

7. There is an empty cutout which will mount the standard IEC digital interface connector. The connector is not supplied with this option.

## Wire Use

1. Hook up wire with square pin receptacles on both ends. These may be used for low frequency or dc circuits where impedance levels and crosstalk are not a problem. The wire is supplied for connection between compartments (adjacent or nonadjacent) or between a compartment and the rear panel. For connection to the rear panel, cut to length then tin and solder the end going to the rear panel connector.
2. Coaxial wire with square pin receptacles on both ends. These are used for connections which require shielding or which must maintain a  $50 \Omega$  characteristic impedance. The outer conductor should be connected to either chassis ground or circuit ground. Plug-in lines which require coax leads usually have a specified ground pin assignment. If necessary, establish auxiliary ground connections at the appropriate wire ends. The coaxial wire is supplied for connection between compartments (adjacent or nonadjacent) or between a compartment and the rear panel. For connection to the rear panel, cut to length then tin and solder the end going to the rear panel connector.



# REPLACEABLE ELECTRICAL PARTS

## PARTS ORDERING INFORMATION

Replacement parts are available from or through your local Tektronix, Inc. Field Office or representative.

Changes to Tektronix instruments are sometimes made to accommodate improved components as they become available, and to give you the benefit of the latest circuit improvements developed in our engineering department. It is therefore important, when ordering parts, to include the following information in your order: Part number, instrument type or number, serial number, and modification number if applicable.

If a part you have ordered has been replaced with a new or improved part, your local Tektronix, Inc. Field Office or representative will contact you concerning any change in part number.

Change information, if any, is located at the rear of this manual.

### LIST OF ASSEMBLIES

A list of assemblies can be found at the beginning of the Electrical Parts List. The assemblies are listed in numerical order. When the complete component number of a part is known, this list will identify the assembly in which the part is located.

### CROSS INDEX-MFR. CODE NUMBER TO MANUFACTURER

The Mfr. Code Number to Manufacturer index for the Electrical Parts List is located immediately after this page. The Cross Index provides codes, names and addresses of manufacturers of components listed in the Electrical Parts List.

### ABBREVIATIONS

Abbreviations conform to American National Standard Y1.1.

### COMPONENT NUMBER (column one of the Electrical Parts List)

A numbering method has been used to identify assemblies, subassemblies and parts. Examples of this numbering method and typical expansions are illustrated by the following:

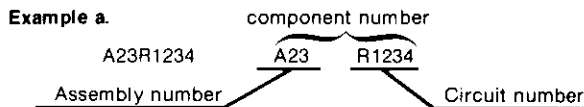

**Read: Resistor 1234 of Assembly 23**

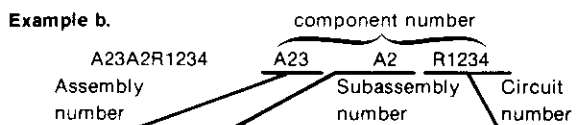

**Read: Resistor 1234 of Subassembly 2 of Assembly 23**

Only the circuit number will appear on the diagrams and circuit board illustrations. Each diagram and circuit board illustration is clearly marked with the assembly number. Assembly numbers are also marked on the mechanical exploded views located in the Mechanical Parts List. The component number is obtained by adding the assembly number prefix to the circuit number.

The Electrical Parts List is divided and arranged by assemblies in numerical sequence (e.g., assembly A1 with its subassemblies and parts, precedes assembly A2 with its subassemblies and parts).

Chassis-mounted parts have no assembly number prefix and are located at the end of the Electrical Parts List.

### TEKTRONIX PART NO. (column two of the Electrical Parts List)

Indicates part number to be used when ordering replacement part from Tektronix.

### SERIAL/MODEL NO. (columns three and four of the Electrical Parts List)

Column three (3) indicates the serial number at which the part was first used. Column four (4) indicates the serial number at which the part was removed. No serial number entered indicates part is good for all serial numbers.

### NAME & DESCRIPTION (column five of the Electrical Parts List)

In the Parts List, an Item Name is separated from the description by a colon (:). Because of space limitations, an Item Name may sometimes appear as incomplete. For further Item Name identification, the U.S. Federal Cataloging Handbook H6-1 can be utilized where possible.

### MFR. CODE (column six of the Electrical Parts List)

Indicates the code number of the actual manufacturer of the part. (Code to name and address cross reference can be found immediately after this page.)

### MFR. PART NUMBER (column seven of the Electrical Parts List)

Indicates actual manufacturers part number.

CROSS INDEX—MFR. CODE NUMBER TO MANUFACTURER

| Mfr. Code | Manufacturer   | Address                                  | City, State, Zip          |
|-----------|--|--|---------------------------|
| 000FJ     | MARCOM SWITCHES INC.   | 67 ALBANY STREET                         | CAZENOVIA, N.Y. 13035     |
| 00779     | AMP, INC.  | P O BOX 3608                             | HARRISBURG, PA 17105      |
| 00853     | SANGAMO ELECTRIC CO., S. CAROLINA DIV.                                       | P O BOX 128                              | PICKENS, SC 29671         |
| 01002     | GENERAL ELECTRIC COMPANY, INDUSTRIAL AND POWER CAPACITOR PRODUCTS DEPARTMENT | JOHN STREET                              | HUDSON FALLS, NY 12839    |
| 01121     | ALLEN-BRADLEY COMPANY  | 1201 2ND STREET SOUTH                    | MILWAUKEE, WI 53204       |
| 01281     | TRW ELECTRONIC COMPONENTS, SEMICONDUCTOR OPERATIONS                          | 14520 AVIATION BLVD.                     | LAWNDALE, CA 90260        |
| 01295     | TEXAS INSTRUMENTS, INC., SEMICONDUCTOR GROUP                                 | P O BOX 5012, 13500 N CENTRAL EXPRESSWAY | DALLAS, TX 75222          |
| 02777     | HOPKINS ENGINEERING COMPANY  | 12900 FOOTHILL BLVD.                     | SAN FERNANDO, CA 91342    |
| 03508     | GENERAL ELECTRIC COMPANY, SEMI-CONDUCTOR PRODUCTS DEPARTMENT                 | ELECTRONICS PARK                         | SYRACUSE, NY 13201        |
| 04222     | AVX CERAMICS, DIVISION OF AVX CORP.  | P O BOX 867, 19TH AVE. SOUTH             | MYRTLE BEACH, SC 29577    |
| 04713     | MOTOROLA, INC., SEMICONDUCTOR PROD. DIV.                                     | 5005 E MCDOWELL RD, PO BOX 20923         | PHOENIX, AZ 85036         |
| 05397     | UNION CARBIDE CORPORATION, MATERIALS SYSTEMS DIVISION                        | 11901 MADISON AVENUE                     | CLEVELAND, OH 44101       |
| 05828     | GENERAL INSTRUMENT CORP ELECTRONIC SYSTEMS DIV.                              | 600 W JOHN ST.                           | HICKSVILLE LI, NY 11802   |
| 07263     | FAIRCHILD SEMICONDUCTOR, A DIV. OF FAIRCHILD CAMERA AND INSTRUMENT CORP.     | 464 ELLIS STREET                         | MOUNTAIN VIEW, CA 94042   |
| 08057     | MAGNETICS DIV OF SPANG INDST. INC.   | 230 ADRIAN RD.                           | MILLBRAE, CA 94030        |
| 12969     | UNITRODE CORPORATION   | 580 PLEASANT STREET                      | WATERTOWN, MA 02172       |
| 14193     | CAL-R, INC.  | 1601 OLYMPIC BLVD.                       | SANTA MONICA, CA 90404    |
| 14433     | ITT SEMICONDUCTORS   | 3301 ELECTRONICS WAY<br>P O BOX 3049     | WEST PALM BEACH, FL 33402 |
| 14552     | MICRO SEMICONDUCTOR CORP.  | 2830 F FAIRVIEW ST.                      | SANTA ANA, CA 92704       |
| 14604     | ELMWOOD SENSORS, INC.  | 1655 ELMWOOD AVENUE                      | CRANSTON, RI 02907        |
| 14752     | ELECTRO CUBE INC.  | 1710 S. DEL MAR AVE.                     | SAN GABRIEL, CA 91776     |
| 15454     | RODAN INDUSTRIES, INC.   | 2905 BLUE STAR ST.                       | ANAHEIM, CA 92806         |
| 22526     | BERG ELECTRONICS, INC.   | YOUK EXPRESSWAY                          | NEW CUMBERLAND, PA 17070  |
| 27014     | NATIONAL SEMICONDUCTOR CORP.   | 2900 SEMICONDUCTOR DR.                   | SANTA CLARA, CA 95051     |
| 27264     | MOLEX PRODUCTS CO.   | 5224 KATRINE AVE.                        | DOWNERS GROVE, IL 60515   |
| 32997     | BOURNS, INC., TRIMPOT PRODUCTS DIV.  | 1200 COLUMBIA AVE.                       | RIVERSIDE, CA 92507       |
| 54473     | MATSUSHITA ELECTRIC, CORP. OF AMERICA  | 1 PANASONIC WAY                          | SECAUCUS, NJ 07094        |
| 55210     | GETTIG ENG. AND MFG. COMPANY   | PO BOX 85, OFF ROUTE 45                  | SPRING MILLS, PA 16875    |
| 55680     | NICHICON/AMERICA/CORP.   | 6435 N PROESEL AVENUE                    | CHICAGO, IL 60645         |
| 56289     | SPRAGUE ELECTRIC CO.   | 87 MARSHALL ST.                          | NORTH ADAMS, MA 01247     |
| 59660     | TUSONIX INC.   | 2155 N FORBES BLVD                       | TUCSON, AZ 85705          |
| 71400     | BUSSMAN MFG., DIVISION OF MCGRAW-EDISON CO.                                  | 2536 W. UNIVERSITY ST.                   | ST. LOUIS, MO 63107       |
| 72982     | ERIE TECHNOLOGICAL PRODUCTS, INC.  | 644 W. 12TH ST.                          | ERIE, PA 16512            |
| 74276     | SIGNALITE DIV., GENERAL INSTRUMENT CORP.                                     | 1933 HECK AVE.                           | NEPTUNE, NJ 07753         |
| 75042     | TRW ELECTRONIC COMPONENTS, IRC FIXED RESISTORS, PHILADELPHIA DIVISION        | 401 N. BROAD ST.                         | PHILADELPHIA, PA 19108    |
| 78488     | STACKPOLE CARBON CO.   |  | ST. MARYS, PA 15857       |
| 80009     | TEKTRONIX, INC.  | P O BOX 500                              | BEAVERTON, OR 97077       |
| 82877     | ROTRON, INC.   | 7-9 HASBROUCK LANE                       | WOODSTOCK, NY 12498       |
| 84411     | TRW ELECTRONIC COMPONENTS, TRW CAPACITORS                                    | 112 W. FIRST ST.                         | OGALLALA, NE 69153        |
| 90201     | MALLORY CAPACITOR CO., DIV. OF P. R. MALLORY AND CO., INC.                   | 3029 E. WASHINGTON STREET                | INDIANAPOLIS, IN 46206    |
| 91637     | DALE ELECTRONICS, INC.   | P. O. BOX 372                            | COLUMBUS, NE 68601        |
| 95238     | CONTINENTAL CONNECTOR CORP.  | P. O. BOX 609<br>34-63 56TH ST.          | WOODSIDE, NY 11377        |



| Component No. | Tektronix Part No. | Serial/Model No. Eff Dscont | Name & Description   | Mfr Code | Mfr Part Number  |
|---------------|--------------------|-----------------------------|--|----------|------------------|
| A10           | 670-6800-00        |                             | CKT BOARD ASSY:MAIN INTERCONNECT (STANDARD ONLY)               | 80009    | 670-6800-00      |
| A10           | 670-6898-00        |                             | CKT BOARD ASSY:MAIN INTERCONNECT (OPTION 02 ONLY)              | 80009    | 670-6898-00      |
| A11           | 670-6802-00        |                             | CKT BOARD ASSY:POWER SUPPLY SECONDARY                          | 80009    | 670-6802-00      |
| A13           | 670-6801-00        |                             | CKT BOARD ASSY:POWER SUPPLY PRIMARY                            | 80009    | 670-6801-00      |
| A14           | 670-7057-00        |                             | CKT BOARD ASSY:LINE FILTER                                     | 80009    | 670-7057-00      |
| A16           | 670-7179-00        |                             | CKT BOARD ASSY:GPIB INTERFACE                                  | 80009    | 670-7179-00      |
| A10           | -----              |                             | CKT BOARD ASSY:MAIN INTERCONNECT                               |          |                  |
| A10C1010      | 281-0774-00        |                             | CAP.,FXD,CER DI:0.022UF,20%,100V                               | 12969    | CGE223MEZ        |
| A10C1011      | 281-0775-00        |                             | CAP.,FXD,CER DI:0.1UF,20%,50V                                  | 72982    | 8005D9AABZ5U104M |
| A10C1012      | 281-0775-00        |                             | CAP.,FXD,CER DI:0.1UF,20%,50V                                  | 72982    | 8005D9AABZ5U104M |
| A10C1020      | 281-0775-00        |                             | CAP.,FXD,CER DI:0.1UF,20%,50V                                  | 72982    | 8005D9AABZ5U104M |
| A10C1021      | 281-0774-00        |                             | CAP.,FXD,CER DI:0.022UF,20%,100V                               | 12969    | CGE223MEZ        |
| A10C1110      | 281-0774-00        |                             | CAP.,FXD,CER DI:0.022UF,20%,100V                               | 12969    | CGE223MEZ        |
| A10C1210      | 281-0774-00        |                             | CAP.,FXD,CER DI:0.022UF,20%,100V                               | 12969    | CGE223MEZ        |
| A10C1211      | 281-0775-00        |                             | CAP.,FXD,CER DI:0.1UF,20%,50V                                  | 72982    | 8005D9AABZ5U104M |
| A10C1212      | 281-0775-00        |                             | CAP.,FXD,CER DI:0.1UF,20%,50V                                  | 72982    | 8005D9AABZ5U104M |
| A10C1213      | 281-0774-00        |                             | CAP.,FXD,CER DI:0.022UF,20%,100V                               | 12969    | CGE223MEZ        |
| A10C1220      | 281-0775-00        |                             | CAP.,FXD,CER DI:0.1UF,20%,50V                                  | 72982    | 8005D9AABZ5U104M |
| A10C1221      | 281-0774-00        |                             | CAP.,FXD,CER DI:0.022UF,20%,100V                               | 12969    | CGE223MEZ        |
| A10C1310      | 281-0774-00        |                             | CAP.,FXD,CER DI:0.022UF,20%,100V                               | 12969    | CGE223MEZ        |
| A10C1311      | 281-0775-00        |                             | CAP.,FXD,CER DI:0.1UF,20%,50V                                  | 72982    | 8005D9AABZ5U104M |
| A10C1312      | 281-0775-00        |                             | CAP.,FXD,CER DI:0.1UF,20%,50V                                  | 72982    | 8005D9AABZ5U104M |
| A10C1320      | 281-0775-00        |                             | CAP.,FXD,CER DI:0.1UF,20%,50V                                  | 72982    | 8005D9AABZ5U104M |
| A10C1321      | 281-0774-00        |                             | CAP.,FXD,CER DI:0.022UF,20%,100V                               | 12969    | CGE223MEZ        |
| A10CR1010     | 152-0198-00        |                             | SEMICONV DEVICE:SILICON,200V,3A                                | 03508    | 1N5624           |
| A10CR1011     | 152-0198-00        |                             | SEMICONV DEVICE:SILICON,200V,3A                                | 03508    | 1N5624           |
| A10CR1120     | 152-0198-00        |                             | SEMICONV DEVICE:SILICON,200V,3A                                | 03508    | 1N5624           |
| A10E500       | 276-0599-00        |                             | CORE,EM:TOROID,FERRITE 0.615 OD                                | 78488    | #57-1540         |
| A10J1000      | 131-1078-00        |                             | CONNECTOR,RCPT,:28/56 CONTACT                                  | 95238    | 600-1156Y256DF30 |
| A10J1110      | 131-0608-00        |                             | TERMINAL,PIN:0.365 L X 0.025 PH BRZ GOLD (QTY OF 33 STANDARD)  | 22526    | 47357            |
| A10J1110      | 131-0608-00        |                             | TERMINAL,PIN:0.365 L X 0.025 PH BRZ GOLD (QTY OF 93 OPTION 02) | 22526    | 47357            |
| A10J1200      | 131-1078-00        |                             | CONNECTOR,RCPT,:28/56 CONTACT                                  | 95238    | 600-1156Y256DF30 |
| A10J1300      | 131-1078-00        |                             | CONNECTOR,RCPT,:28/56 CONTACT                                  | 95238    | 600-1156Y256DF30 |
| A10Q1125      | 151-0462-00        |                             | TRANSISTOR:SILICON,PNP   | 04713    | TIP30C           |
| A10R1123      | 308-0142-00        |                             | RES.,FXD,WW:30 OHM,5%,3W                                       | 91637    | RS2B-K30R00J     |
| A10R1126      | 315-0332-00        |                             | RES.,FXD,CMPSN:3.3K OHM,5%,0.25W                               | 01121    | CB3325           |
| A10R1127      | 308-0740-00        |                             | RES.,FXD,WW:20 OHM,1%,3W                                       | 91637    | RS2B-K20R00F     |
| A10R1210      | 315-0100-00        |                             | RES.,FXD,CMPSN:10 OHM,5%,0.25W                                 | 01121    | CB1005           |

Replaceable Electrical Parts—TM 5003

| Component No. | Tektronix Part No. | Serial/Model No. Eff Dscont | Name & Description                    | Mfr Code | Mfr Part Number  |
|---------------|--------------------|-----------------------------|---------------------------------------|----------|------------------|
| All           | -----              |                             | CKT BOARD ASSY:POWER SUPPLY SECONDARY |          |                  |
| A11C1020      | 283-0203-00        |                             | CAP.,FXD,CER DI:0.47UF,20%,50V        | 72982    | 8131N075E474M    |
| A11C1030      | 290-0901-00        |                             | CAP.,FXD,ELCTLT:800UF,+50-10%,50V     | 05397    | VPR811N050N1L3B  |
| A11C1210      | 283-0203-00        |                             | CAP.,FXD,CER DI:0.47UF,20%,50V        | 72982    | 8131N075E474M    |
| A11C1230      | 290-0901-00        |                             | CAP.,FXD,ELCTLT:800UF,+50-10%,50V     | 05397    | VPR811N050N1L3B  |
| A11C1231      | 290-0818-00        |                             | CAP.,FXD,ELCTLT:390UF,+100-10%,40V    | 56289    | 672D397H040DS5C  |
| A11C1240      | 290-0818-00        |                             | CAP.,FXD,ELCTLT:390UF,+100-10%,40V    | 56289    | 672D397H040DS5C  |
| A11C1310      | 283-0203-00        |                             | CAP.,FXD,CER DI:0.47UF,20%,50V        | 72982    | 8131N075E474M    |
| A11C1320      | 290-0929-00        |                             | CAP.,FXD,ELCTLT:6600UF,+100-10%,12V   | 90201    | VPR662N012N2C3B  |
| A11C1340      | 290-0929-00        |                             | CAP.,FXD,ELCTLT:6600UF,+100-10%,12V   | 90201    | VPR662N012N2C3B  |
| A11C1410      | 281-0813-00        |                             | CAP.,FXD,CER DI:0.047UF,20%,50V       | 04222    | GC705-E-473M     |
| A11C1411      | 283-0203-00        |                             | CAP.,FXD,CER DI:0.47UF,20%,50V        | 72982    | 8131N075E474M    |
| A11C1412      | 283-0203-00        |                             | CAP.,FXD,CER DI:0.47UF,20%,50V        | 72982    | 8131N075E474M    |
| A11C1420      | 290-0929-00        |                             | CAP.,FXD,ELCTLT:6600UF,+100-10%,12V   | 90201    | VPR662N012N2C3B  |
| A11C1450      | 285-0889-00        |                             | CAP.,FXD,PLSTC:0.0027UF,5%,100V       | 01002    | 61F10AC272       |
| A11C1451      | 281-0773-00        |                             | CAP.,FXD,CER DI:0.01UF,10%,100V       | 04222    | GC70-1C103K      |
| A11C1620      | 290-0804-00        |                             | CAP.,FXD,ELCTLT:10UF,+50-10%,25V      | 55680    | 25ULA10V-T       |
| A11C1621      | 283-0680-00        |                             | CAP.,FXD,MICA D:330PF,1%,500V         | 00853    | D155E331F0       |
| A11C1630      | 281-0773-00        |                             | CAP.,FXD,CER DI:0.01UF,10%,100V       | 04222    | GC70-1C103K      |
| A11C1631      | 281-0775-00        |                             | CAP.,FXD,CER DI:0.1UF,20%,50V         | 72982    | 8005D9AABZ5U104M |
| A11C1640      | 283-0142-00        |                             | CAP.,FXD,CER DI:0.0027UF,5%,200V      | 59660    | 875-571-Y5E0272J |
| A11C1641      | 281-0813-00        |                             | CAP.,FXD,CER DI:0.047UF,20%,50V       | 04222    | GC705-E-473M     |
| A11C1700      | 283-0672-00        |                             | CAP.,FXD,MICA D:200PF,1%,500V         | 00853    | D155F2010F0      |
| A11C1710      | 283-0659-00        |                             | CAP.,FXD,MICA D:1160PF,2%,500V        | 00853    | D195C1161G0      |
| A11C1730      | 290-0771-00        |                             | CAP.,FXD,ELCTLT:220UF,+50-10%,10VDC   | 54473    | ECE-A10V220L     |
| A11C1740      | 281-0814-00        |                             | CAP.,FXD,CER DI:100PF,10%,100V        | 04222    | GC70-1-A101K     |
| A11C1760      | 290-0804-00        |                             | CAP.,FXD,ELCTLT:10UF,+50-10%,25V      | 55680    | 25ULA10V-T       |
| A11C1761      | 290-0919-00        |                             | CAP.,FXD,ELCTLT:470UF,+50-10%,35V     | 55680    | 35ULB470-T       |
| A11C1830      | 281-0788-00        |                             | CAP.,FXD,CER DI:470PF,10%,100V        | 72982    | 8005H9AADW5R471K |
| A11C1831      | 290-0771-00        |                             | CAP.,FXD,ELCTLT:220UF,+50-10%,10VDC   | 54473    | ECE-A10V220L     |
| A11C1850      | 281-0773-00        |                             | CAP.,FXD,CER DI:0.01UF,10%,100V       | 04222    | GC70-1C103K      |
| A11C1851      | 290-0891-00        |                             | CAP.,FXD,ELCTLT:1UF,+75-10%,50V       | 55680    | 25U1A10V-T       |
| A11CR500      | 152-0762-00        |                             | SEMICONV DEVICE:SILICON,35V,30A       | 01281    | SD-241           |
| A11CR1010     | 152-0655-00        |                             | SEMICONV DEVICE:SILICON,100V,3A       | 03508    | A115AX39         |
| A11CR1020     | 152-0655-00        |                             | SEMICONV DEVICE:SILICON,100V,3A       | 03508    | A115AX39         |
| A11CR1021     | 152-0655-00        |                             | SEMICONV DEVICE:SILICON,100V,3A       | 03508    | A115AX39         |
| A11CR1120     | 152-0655-00        |                             | SEMICONV DEVICE:SILICON,100V,3A       | 03508    | A115AX39         |
| A11CR1450     | 152-0141-02        |                             | SEMICONV DEVICE:SILICON,30V,150MA     | 01295    | 1N4152R          |
| A11CR1451     | 152-0141-02        |                             | SEMICONV DEVICE:SILICON,30V,150MA     | 01295    | 1N4152R          |
| A11CR1500     | 152-0107-00        |                             | SEMICONV DEVICE:SILICON,400V,400MA    | 01295    | G727             |
| A11CR1501     | 152-0107-00        |                             | SEMICONV DEVICE:SILICON,400V,400MA    | 01295    | G727             |
| A11CR1502     | 152-0141-02        |                             | SEMICONV DEVICE:SILICON,30V,150MA     | 01295    | 1N4152R          |
| A11CR1510     | 152-0141-02        |                             | SEMICONV DEVICE:SILICON,30V,150MA     | 01295    | 1N4152R          |
| A11CR1511     | 152-0141-02        |                             | SEMICONV DEVICE:SILICON,30V,150MA     | 01295    | 1N4152R          |
| A11CR1512     | 152-0141-02        |                             | SEMICONV DEVICE:SILICON,30V,150MA     | 01295    | 1N4152R          |
| A11CR1550     | 152-0141-02        |                             | SEMICONV DEVICE:SILICON,30V,150MA     | 01295    | 1N4152R          |
| A11CR1560     | 152-0066-00        |                             | SEMICONV DEVICE:SILICON,400V,750MA    | 14433    | LG4016           |
| A11CRJ561     | 152-0066-00        |                             | SEMICONV DEVICE:SILICON,400V,750MA    | 14433    | LG4016           |
| A11CR1610     | 152-0141-02        |                             | SEMICONV DEVICE:SILICON,30V,150MA     | 01295    | 1N4152R          |
| A11CR1640     | 152-0141-02        |                             | SEMICONV DEVICE:SILICON,30V,150MA     | 01295    | 1N4152R          |
| A11CR1660     | 152-0066-00        |                             | SEMICONV DEVICE:SILICON,400V,750MA    | 14433    | LG4016           |
| A11CR1661     | 152-0066-00        |                             | SEMICONV DEVICE:SILICON,400V,750MA    | 14433    | LG4016           |
| A11CR1710     | 152-0141-02        |                             | SEMICONV DEVICE:SILICON,30V,150MA     | 01295    | 1N4152R          |
| A11CR1711     | 152-0141-02        |                             | SEMICONV DEVICE:SILICON,30V,150MA     | 01295    | 1N4152R          |
| A11CR1720     | 152-0141-02        |                             | SEMICONV DEVICE:SILICON,30V,150MA     | 01295    | 1N4152R          |
| A11CR1730     | 152-0141-02        |                             | SEMICONV DEVICE:SILICON,30V,150MA     | 01295    | 1N4152R          |
| A11CR1731     | 152-0141-02        |                             | SEMICONV DEVICE:SILICON,30V,150MA     | 01295    | 1N4152R          |

| Component No. | Tektronix Part No. | Serial/Model No. Eff Dscont | Name & Description                                 | Mfr Code | Mfr Part Number |
|---------------|--------------------|-----------------------------|--|----------|-----------------|
| A11CR1830     | 152-0141-02        |                             | SEMICONV DEVICE: SILICON, 30V, 150MA               | 01295    | 1N4152R         |
| A11CR1840     | 152-0141-02        |                             | SEMICONV DEVICE: SILICON, 30V, 150MA               | 01295    | 1N4152R         |
| A11CR1841     | 152-0141-02        |                             | SEMICONV DEVICE: SILICON, 30V, 150MA               | 01295    | 1N4152R         |
| A11E500       | 276-0635-00        |                             | CORE, EM: TOROID, FERRITE                          | 08057    | 7J-41405-TC     |
| A11F1660      | 159-0022-00        |                             | FUSE, CARTRIDGE: 3AG, 1A, 250V, FAST-BLOW          | 71400    | AGC 1           |
| A11J1060      | 131-1816-00        |                             | TERM, QIK DISC.: 0.25 X 0.315 X 0.032 DOUBLE       | 00779    | 41480           |
| A11J1160      | 131-1816-00        |                             | TERM, QIK DISC.: 0.25 X 0.315 X 0.032 DOUBLE       | 00779    | 41480           |
| A11J1260      | 131-1816-00        |                             | TERM, QIK DISC.: 0.25 X 0.315 X 0.032 DOUBLE       | 00779    | 41480           |
| A11J1300      | 131-0608-00        |                             | TERMINAL, PIN: 0.365 L X 0.025 PH BRZ GOLD (QTY 3) | 22526    | 47357           |
| A11J1360      | 131-1816-00        |                             | TERM, QIK DISC.: 0.25 X 0.315 X 0.032 DOUBLE       | 00779    | 41480           |
| A11J1463      | 131-0608-00        |                             | TERMINAL, PIN: 0.365 L X 0.025 PH BRZ GOLD (QTY 3) | 22526    | 47357           |
| A11L1140      | 108-1041-00        |                             | COIL, RF: FXD, 25UH                                | 80009    | 108-1041-00     |
| A11L1141      | 108-1041-00        |                             | COIL, RF: FXD, 25UH                                | 80009    | 108-1041-00     |
| A11L1430      | 108-1022-00        |                             | COIL, RF: FIXED, 11UH                              | 80009    | 108-1022-00     |
| A11Q1400      | 151-0302-00        |                             | TRANSISTOR: SILICON, NPN                           | 07263    | S038487         |
| A11Q1401      | 151-0302-00        |                             | TRANSISTOR: SILICON, NPN                           | 07263    | S038487         |
| A11Q1650      | 151-0190-00        |                             | TRANSISTOR: SILICON, NPN                           | 07263    | S032677         |
| A11R1150      | 308-0426-00        |                             | RES., FXD, WW: 470 OHM, 5%, 3W                     | 91637    | CW2B-470R0J     |
| A11R1250      | 308-0426-00        |                             | RES., FXD, WW: 470 OHM, 5%, 3W                     | 91637    | CW2B-470R0J     |
| A11R1350      | 308-0402-00        |                             | RES., FXD, WW: 30 OHM, 5%, 5W                      | 14193    | SAV46           |
| A11R1360      | 321-0338-00        |                             | RES., FXD, FILM: 32.4K OHM, 1%, 0.125W             | 91637    | MFF1816G32401F  |
| A11R1361      | 315-0751-00        |                             | RES., FXD, CMPSN: 750 OHM, 5%, 0.25W               | 01121    | CB7515          |
| A11R1400      | 315-0751-00        |                             | RES., FXD, CMPSN: 750 OHM, 5%, 0.25W               | 01121    | CB7515          |
| A11R1410      | 315-0103-00        |                             | RES., FXD, CMPSN: 10K OHM, 5%, 0.25W               | 01121    | CB1035          |
| A11R1440      | 321-0249-00        |                             | RES., FXD, FILM: 3.83K OHM, 1%, 0.125W             | 91637    | MFF1816G38300F  |
| A11R1441      | 321-0279-00        |                             | RES., FXD, FILM: 7.87K OHM, 1%, 0.125W             | 91637    | MFF1816G78700F  |
| A11R1442      | 315-0104-00        |                             | RES., FXD, CMPSN: 100K OHM, 5%, 0.25W              | 01121    | CB1045          |
| A11R1450      | 315-0104-00        |                             | RES., FXD, CMPSN: 100K OHM, 5%, 0.25W              | 01121    | CB1045          |
| A11R1451      | 315-0224-00        |                             | RES., FXD, CMPSN: 220K OHM, 5%, 0.25W              | 01121    | CB2245          |
| A11R1452      | 315-0154-00        |                             | RES., FXD, CMPSN: 150K OHM, 5%, 0.25W              | 01121    | CB1545          |
| A11R1453      | 321-0225-00        |                             | RES., FXD, FILM: 2.15K OHM, 1%, 0.125W             | 91637    | MFF1816G21500F  |
| A11R1460      | 321-0279-00        |                             | RES., FXD, FILM: 7.87K OHM, 1%, 0.125W             | 91637    | MFF1816G78700F  |
| A11R1461      | 321-0279-00        |                             | RES., FXD, FILM: 7.87K OHM, 1%, 0.125W             | 91637    | MFF1816G78700F  |
| A11R1462      | 321-0322-00        |                             | RES., FXD, FILM: 22.1K OHM, 1%, 0.125W             | 91637    | MFF1816G22101F  |
| A11R1500      | 315-0622-00        |                             | RES., FXD, CMPSN: 6.2K OHM, 5%, 0.25W              | 01121    | CB6225          |
| A11R1501      | 315-0622-00        |                             | RES., FXD, CMPSN: 6.2K OHM, 5%, 0.25W              | 01121    | CB6225          |
| A11R1510      | 323-0117-00        |                             | RES., FXD, FILM: 162 OHM, 1%, 0.50W                | 75042    | CECT0-1620F     |
| A11R1511      | 315-0103-00        |                             | RES., FXD, CMPSN: 10K OHM, 5%, 0.25W               | 01121    | CB1035          |
| A11R1520      | 315-0103-00        |                             | RES., FXD, CMPSN: 10K OHM, 5%, 0.25W               | 01121    | CB1035          |
| A11R1521      | 315-0102-00        |                             | RES., FXD, CMPSN: 1K OHM, 5%, 0.25W                | 01121    | CB1025          |
| A11R1530      | 311-1225-00        |                             | RES., VAR, NONWTR: 1K OHM, 20%, 0.50W              | 32997    | 3386F-T04-102   |
| A11R1540      | 315-0104-00        |                             | RES., FXD, CMPSN: 100K OHM, 5%, 0.25W              | 01121    | CB1045          |
| A11R1541      | 315-0103-00        |                             | RES., FXD, CMPSN: 10K OHM, 5%, 0.25W               | 01121    | CB1035          |
| A11R1550      | 315-0130-00        |                             | RES., FXD, CMPSN: 13 OHM, 5%, 0.25W                | 01121    | CB1305          |
| A11R1610      | 321-0308-00        |                             | RES., FXD, FILM: 15.8K OHM, 1%, 0.125W             | 91637    | MFF1816G15801F  |
| A11R1620      | 321-0349-00        |                             | RES., FXD, FILM: 42.2K OHM, 1%, 0.125W             | 91637    | MFF1816G42201F  |
| A11R1621      | 321-0356-00        |                             | RES., FXD, FILM: 49.9K OHM, 1%, 0.125W             | 91637    | MFF1816G49901F  |
| A11R1630      | 321-0279-00        |                             | RES., FXD, FILM: 7.87K OHM, 1%, 0.125W             | 91637    | MFF1816G78700F  |
| A11R1631      | 315-0332-00        |                             | RES., FXD, CMPSN: 3.3K OHM, 5%, 0.25W              | 01121    | CB3325          |
| A11R1632      | 315-0104-00        |                             | RES., FXD, CMPSN: 100K OHM, 5%, 0.25W              | 01121    | CB1045          |
| A11R1640      | 315-0913-00        |                             | RES., FXD, CMPSN: 91K OHM, 5%, 0.25W               | 01121    | CB9135          |
| A11R1650      | 321-0241-00        |                             | RES., FXD, FILM: 3.16K OHM, 1%, 0.125W             | 91637    | MFF1816G31600F  |
| A11R1651      | 315-0223-00        |                             | RES., FXD, CMPSN: 22K OHM, 5%, 0.25W               | 01121    | CB2235          |
| A11R1652      | 315-0130-00        |                             | RES., FXD, CMPSN: 13 OHM, 5%, 0.25W                | 01121    | CB1305          |
| A11R1653      | 315-0130-00        |                             | RES., FXD, CMPSN: 13 OHM, 5%, 0.25W                | 01121    | CB1305          |

Replaceable Electrical Parts—TM 5003

| Component No. | Tektronix Part No. | Serial/Model No. Eff Dscont | Name & Description                        | Mfr Code | Mfr Part Number |
|---------------|--------------------|-----------------------------|---|----------|-----------------|
| A11R1720      | 315-0224-00        |                             | RES., FXD, CMPSN: 220K OHM, 5%, 0.25W     | 01121    | CB2245          |
| A11R1730      | 315-0104-00        |                             | RES., FXD, CMPSN: 100K OHM, 5%, 0.25W     | 01121    | CB1045          |
| A11R1740      | 315-0333-00        |                             | RES., FXD, CMPSN: 33K OHM, 5%, 0.25W      | 01121    | CB3335          |
| A11R1741      | 315-0223-00        |                             | RES., FXD, CMPSN: 22K OHM, 5%, 0.25W      | 01121    | CB2235          |
| A11R1742      | 321-0279-00        |                             | RES., FXD, FILM: 7.87K OHM, 1%, 0.125W    | 91637    | MFF1816G78700F  |
| A11R1743      | 315-0332-00        |                             | RES., FXD, CMPSN: 3.3K OHM, 5%, 0.25W     | 01121    | CB3325          |
| A11R1750      | 315-0913-00        |                             | RES., FXD, CMPSN: 91K OHM, 5%, 0.25W      | 01121    | CB9135          |
| A11R1751      | 315-0822-00        |                             | RES., FXD, CMPSN: 8.2K OHM, 5%, 0.25W     | 01121    | CB8225          |
| A11R1752      | 315-0223-00        |                             | RES., FXD, CMPSN: 22K OHM, 5%, 0.25W      | 01121    | CB2235          |
| A11R1820      | 315-0102-00        |                             | RES., FXD, CMPSN: 1K OHM, 5%, 0.25W       | 01121    | CB1025          |
| A11R1821      | 315-0223-00        |                             | RES., FXD, CMPSN: 22K OHM, 5%, 0.25W      | 01121    | CB2235          |
| A11R1830      | 311-1228-00        |                             | RES., VAR, NONWIR: 10K OHM, 20%, 0.50W    | 32997    | 3386F-T04-103   |
| A11R1840      | 315-0103-00        |                             | RES., FXD, CMPSN: 10K OHM, 5%, 0.25W      | 01121    | CB1035          |
| A11R1841      | 315-0103-00        |                             | RES., FXD, CMPSN: 10K OHM, 5%, 0.25W      | 01121    | CB1035          |
| A11R1842      | 315-0104-00        |                             | RES., FXD, CMPSN: 100K OHM, 5%, 0.25W     | 01121    | CB1045          |
| A11T1000      | 120-0747-00        |                             | XFMR, TOROID: 55 TURNS, SINGLE            | 80009    | 120-0747-00     |
| A11T1210      | 120-1332-00        |                             | XFMR, PWR, STPDN: HF CONVERTER            | 80009    | 120-1332-00     |
| A11U1540      | 156-0411-00        |                             | MICROCIRCUIT, LI: QUAD-COMP, SGL SUPPLY   | 27014    | LM339N          |
| A11U1550      | 156-0071-00        |                             | MICROCIRCUIT, LI: VOLTAGE REGULATOR       | 04713    | MC1723CL        |
| A11U1600      | 156-0366-00        |                             | MICROCIRCUIT, DI: DUAL D-TYPE F-F         | 80009    | 156-0366-00     |
| A11U1610      | 156-0754-00        |                             | MICROCIRCUIT, DI: DUAL 4-INPUT NOR GATES  | 80009    | 156-0754-00     |
| A11U1620      | 156-0745-00        |                             | MICROCIRCUIT, DI: HEX INVERTER            | 80009    | 156-0745-00     |
| A11U1720      | 156-1152-00        |                             | MICROCIRCUIT, DI: DUAL PRCN RETR RESET MM | 80009    | 156-1152-00     |
| A11U1850      | 156-0402-00        |                             | MICROCIRCUIT, LI: TIMER                   | 27014    | SL34829         |
| A11VR1753     | 152-0243-00        |                             | SEMICONV DEVICE: ZENER, 0.4W, 15V, 5%     | 14552    | TD3810983       |
| A11W1630      | 131-0566-00        |                             | BUS CONDUCTOR: DUMMY RES, 2.375, 22 AWG   | 55210    | L-2007-1        |

| Component No. | Tektronix Part No. | Serial/Model No. Eff Dscont | Name & Description                       | Mfr Code | Mfr Part Number  |
|---------------|--------------------|-----------------------------|--|----------|------------------|
| A13           | -----              |                             | CKT BOARD ASSY:POWER SUPPLY PRIMARY      |          |                  |
| A13C1000      | 283-0263-00        |                             | CAP.,FXD,CER DI:0.0022UF,20%,3000V       | 56289    | 33C319           |
| A13C1120      | 285-1218-00        |                             | CAP.,FXD,PLASTIC:0.27UF,10%,250VAC       | 14752    | 230D1E274K       |
| A13C1130      | 290-0715-00        |                             | CAP.,FXD,ELCTLT:720UF,+50-75%,200V       | 56289    | 68D10729         |
| A13C1200      | 283-0187-00        |                             | CAP.,FXD,CER DI:0.047UF,10%,400V         | 72982    | 8131N401X5R0473K |
| A13C1210      | 285-0981-00        |                             | CAP.,FXD,PLSTC:2.0UF,10%,400V            | 14752    | C-2176-1         |
| A13C1220      | 283-0044-00        |                             | CAP.,FXD,CER DI:0.001UF,3000V            | 72982    | 3903BW002Y5S102M |
| A13C1230      | 290-0715-00        |                             | CAP.,FXD,ELCTLT:720UF,+50-75%,200V       | 56289    | 68D10729         |
| A13C1310      | 283-0000-00        |                             | CAP.,FXD,CER DI:0.001UF,+100-0%,500V     | 72982    | 831-516E102P     |
| A13C1320      | 285-1205-00        |                             | CAP.,FXD,MTLZED:0.06UF,5%,1000V          | 84411    | TEK-210          |
| A13C1321      | 283-0178-00        |                             | CAP.,FXD,CER DI:0.1UF,+80-20%,100V       | 72982    | 8131N145651 1042 |
| A13C1401      | 283-0194-00        |                             | CAP.,FXD,CER DI:4.7UF,20%,50V            | 72982    | 8151N057Z5U0475M |
| A13C1411      | 283-0194-00        |                             | CAP.,FXD,CER DI:4.7UF,20%,50V            | 72982    | 8151N057Z5U0475M |
| A13C1412      | 283-0000-00        |                             | CAP.,FXD,CER DI:0.001UF,+100-0%,500V     | 72982    | 831-516E102P     |
| A13CR1120     | 152-0750-00        |                             | SEMICONV DEVICE:RECT BRIDGE,600V,3A      | 05828    | RKBPC606         |
| A13CR1300     | 152-0400-00        |                             | SEMICONV DEVICE:SILICON,400V,1A          | 80009    | 152-0400-00      |
| A13CR1301     | 152-0655-00        |                             | SEMICONV DEVICE:SILICON,100V,3A          | 03508    | A115AX39         |
| A13CR1302     | 152-0400-00        |                             | SEMICONV DEVICE:SILICON,400V,1A          | 80009    | 152-0400-00      |
| A13CR1303     | 152-0655-00        |                             | SEMICONV DEVICE:SILICON,100V,3A          | 03508    | A115AX39         |
| A13DS1320     | 150-0030-00        |                             | LAMP,GLOW:NEON,T-2,60 TO 90 VOLTS        | 74276    | NE2V-T           |
| A13E1120      | 119-0181-00        |                             | ARSR,ELEC SURGE:230V,GAS FILLED          | 80009    | 119-0181-00      |
| A13E1220      | 119-0181-00        |                             | ARSR,ELEC SURGE:230V,GAS FILLED          | 80009    | 119-0181-00      |
| A13J1000      | 131-2247-00        |                             | TERM,FEED THRU:3 PIN,INSULATED           | 27264    | 09-60-1031       |
| A13J1420      | 131-2247-00        |                             | TERM,FEED THRU:3 PIN,INSULATED           | 27264    | 09-60-1031       |
| A13J1430      | 131-0608-00        |                             | TERMINAL,PIN:0.365 L X 0.025 PH BRZ GOLD | 22526    | 47357            |
|               | -----              |                             | (QTY 3)                                  |          |                  |
| A13L1112      | 108-1037-00        |                             | COIL,RF:FXD,500UH TOROID                 | 80009    | 108-1037-00      |
| A13L1200      | 108-0678-00        |                             | COIL,RF:1MH                              | 80009    | 108-0678-00      |
| A13L1220      | 108-0973-00        |                             | COIL,RF:FIXED,140UH                      | 80009    | 108-0973-00      |
| A13Q1300      | 151-0678-00        |                             | TRANSISTOR:SILICON,NPN                   | 04713    | MJE13005         |
| A13Q1301      | 151-0678-00        |                             | TRANSISTOR:SILICON,NPN                   | 04713    | MJE13005         |
| A13R1120      | 315-0361-00        |                             | RES.,FXD,CMPSN:360 OHM,5%,0.25W          | 01121    | CB3615           |
| A13R1130      | 303-0154-00        |                             | RES.,FXD,CMPSN:150K OHM,5%,1W            | 01121    | GB1545           |
| A13R1200      | 315-0101-00        |                             | RES.,FXD,CMPSN:100 OHM,5%,0.25W          | 01121    | CB1015           |
| A13R1210      | 308-0365-00        |                             | RES.,FXD,WW:1.5 OHM,5%,3W                | 91637    | CW2B-1R500J      |
| A13R1220      | 301-0471-00        |                             | RES.,FXD,CMPSN:470 OHM,5%,0.50W          | 01121    | EB4715           |
| A13R1230      | 303-0154-00        |                             | RES.,FXD,CMPSN:150K OHM,5%,1W            | 01121    | GB1545           |
| A13R1310      | 305-0470-00        |                             | RES.,FXD,CMPSN:47 OHM,5%,2W              | 01121    | HB4705           |
| A13R1320      | 315-0240-00        |                             | RES.,FXD,CMPSN:24 OHM,5%,0.25W           | 01121    | CB2405           |
| A13R1330      | 301-0685-00        |                             | RES.,FXD,CMPSN:6.8M OHM,5%,0.50W         | 01121    | EB6855           |
| A13R1400      | 308-0686-00        |                             | RES.,FXD,WW:2.2 OHM,5%,2W                | 75042    | BWH-2R200J       |
| A13R1410      | 308-0686-00        |                             | RES.,FXD,WW:2.2 OHM,5%,2W                | 75042    | BWH-2R200J       |
| A13R1420      | 301-0331-00        |                             | RES.,FXD,CMPSN:330 OHM,5%,0.50W          | 01121    | EB3315           |
| A13RT1020     | 307-0350-00        |                             | RES.,THERMAL:7.5 OHM,10%,3.9%/DEG C      | 15454    | 75DJ7R5R0220SS   |
| A13RT1110     | 307-0350-00        |                             | RES.,THERMAL:7.5 OHM,10%,3.9%/DEG C      | 15454    | 75DJ7R5R0220SS   |
| A13T1430      | 120-0744-00        |                             | XFMR,TOROID:5 WINDINGS                   | 80009    | 120-0744-00      |

Replaceable Electrical Parts—TM 5003

| Component No. | Tektronix Part No. | Serial/Model No. Eff Dscont | Name & Description                                  | Mfr Code | Mfr Part Number |
|---------------|--------------------|-----------------------------|---|----------|-----------------|
| A14           | -----              |                             | CKT BOARD ASSY:LINE FILTER                          |          |                 |
| A14C1000      | 283-0263-00        |                             | CAP.,FXD,CER DI:0.0022UF,20%,3000V                  | 56289    | 33C319          |
| A14C1100      | 283-0263-00        |                             | CAP.,FXD,CER DI:0.0022UF,20%,3000V                  | 56289    | 33C319          |
| A14C1101      | 283-0417-00        |                             | CAP.,FXD,CER DI:0.22UF,20%,400V                     | 72982    | 8151-400-651    |
| A14J1100      | 131-0608-00        |                             | TERMINAL,PIN:0.365 L X 0.025 PH BRZ GOLD<br>(QTY 4) | 22526    | 47357           |
| A14J1101      | 131-0608-00        |                             | TERMINAL,PIN:0.365 L X 0.025 PH BRZ GOLD<br>(QTY 4) | 22526    | 47357           |
| A14J1102      | 131-0608-00        |                             | TERMINAL,PIN:0.365 L X 0.025 PH BRZ GOLD<br>(QTY 4) | 22526    | 47357           |
| A14J1103      | 131-0608-00        |                             | TERMINAL,PIN:0.365 L X 0.025 PH BRZ GOLD<br>(QTY 4) | 22526    | 47357           |
| A14J1104      | 131-0608-00        |                             | TERMINAL,PIN:0.365 L X 0.025 PH BRZ GOLD<br>(QTY 4) | 22526    | 47357           |
| A14J1105      | 131-0608-00        |                             | TERMINAL,PIN:0.365 L X 0.025 PH BRZ GOLD<br>(QTY 2) | 22526    | 47357           |
| A14L1000      | 108-0902-00        |                             | COIL,RF:0.4MH,FIXED                                 | 80009    | 108-0902-00     |
| A14L1100      | 108-0902-00        |                             | COIL,RF:0.4MH,FIXED                                 | 80009    | 108-0902-00     |
| A14R1000      | 315-0911-00        |                             | RES.,FXD,CMPSN:910 OHM,5%,0.25W                     | 01121    | CB9115          |
| A14T1000      | 120-1337-00        |                             | TRANSFORMER,RF:COMMON MODE                          | 80009    | 120-1337-00     |
| A16           | -----              |                             | CKT BOARD ASSY:                                     |          |                 |
| A16J1010      | 131-1789-00        |                             | CONN,RCPT,ELEC:RT-ANGLE,2/100.025 SQ PINS           | 22526    | 65268-008       |
| A16J1110      | 131-2542-00        |                             | CONN,RCPT,ELEC:CKT BD,24 CONTACT                    | 00779    | 552791-2        |

Replaceable Electrical Parts—TM 5003

| Component No. | Tektronix Part No. | Serial/Model No. Eff Dscont | Name & Description                            | Mfr Code | Mfr Part Number |
|---------------|--------------------|-----------------------------|---|----------|-----------------|
| CHASSIS PARTS |                    |                             |   |          |                 |
| B500          | 119-0721-00        |                             | FAN, VENTILATING: 75 CFM, 7W, 115VAC, 50/60HZ | 82877    | 027119          |
| F500          | 159-0036-00        |                             | FUSE, CARTRIDGE: 3AG, 7A, 125V, 5SEC          | 71400    | GLH 7           |
|               | -----              |                             | (STANDARD ONLY)                               |          |                 |
| F500          | 159-0017-00        |                             | FUSE, CARTRIDGE: 3AG, 4A, 250V, FAST BLOW     | 71400    | MTH4            |
|               | -----              |                             | (OPTIONS A1, A2, A3, A4 ONLY)                 |          |                 |
| FL500         | 119-0389-00        |                             | FILTER, RAD INTE: 115/230V, 3A                | 02777    | F11935-3        |
| Q500          | 151-0373-00        |                             | TRANSISTOR: SILICON, PNP                      | 80009    | 151-0373-00     |
| Q510          | 151-0436-00        |                             | TRANSISTOR: SILICON, NPN                      | 80009    | 151-0436-00     |
| Q520          | 151-0373-00        |                             | TRANSISTOR: SILICON, PNP                      | 80009    | 151-0373-00     |
| Q530          | 151-0436-00        |                             | TRANSISTOR: SILICON, NPN                      | 80009    | 151-0436-00     |
| Q540          | 151-0373-00        |                             | TRANSISTOR: SILICON, PNP                      | 80009    | 151-0373-00     |
| Q550          | 151-0436-00        |                             | TRANSISTOR: SILICON, NPN                      | 80009    | 151-0436-00     |
| S500          | 260-1961-00        |                             | SWITCH, ROCKER: DPST, 6(4)A, 250V             | 000FJ    | OBD             |
| S501          | 260-1710-00        |                             | SW, THERMOSTATIC: 10A, 250V, OPEN 206 DEG     | 14604    | 2450-47-16      |
| T500          | 120-1333-00        |                             | XFMR, PWR, STPDN: LF                          | 80009    | 120-1333-00     |

